

01b

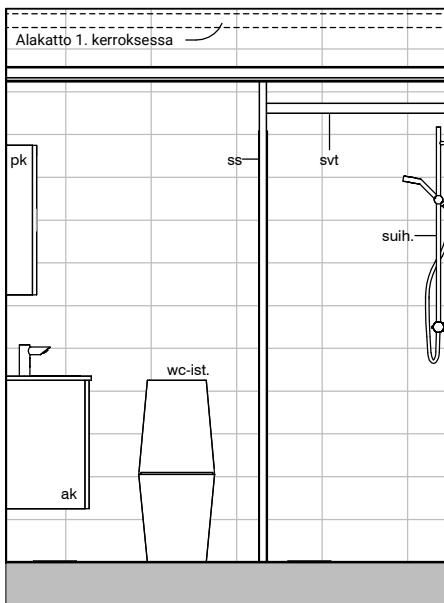

01a

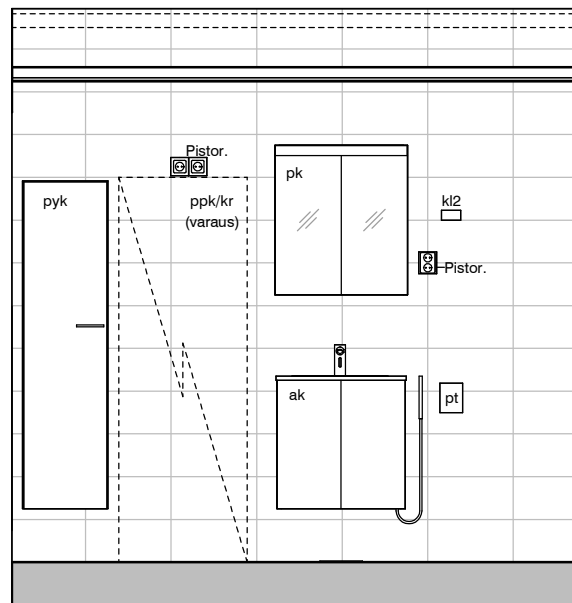

01d

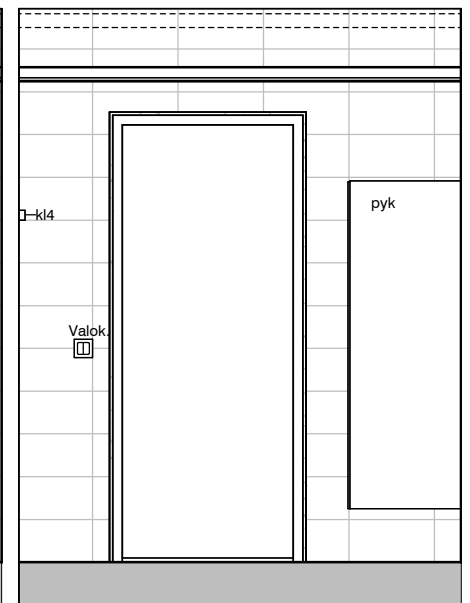

01c

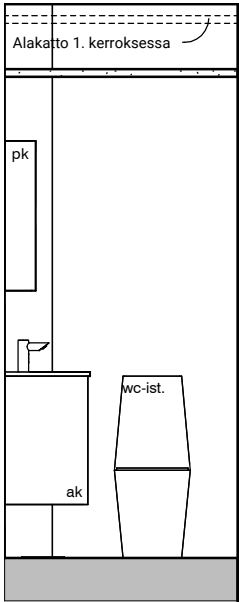
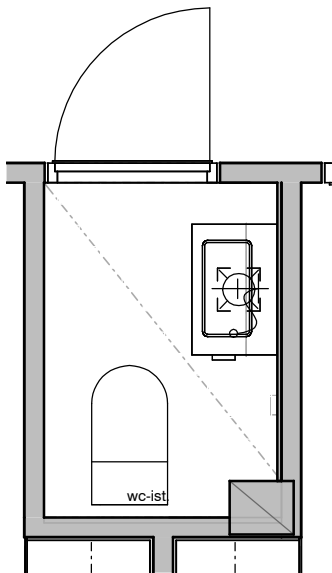

01e

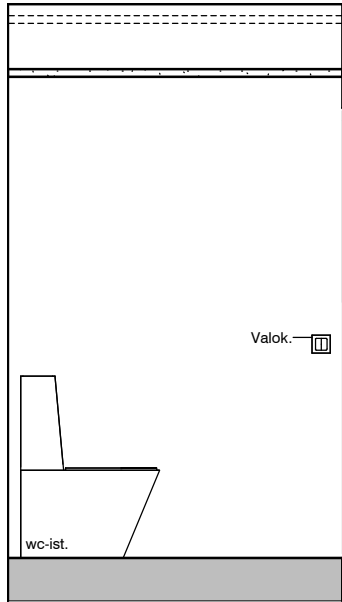

01f

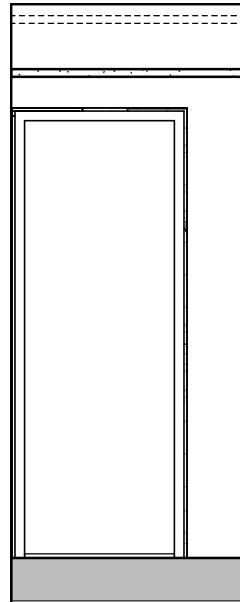

01g

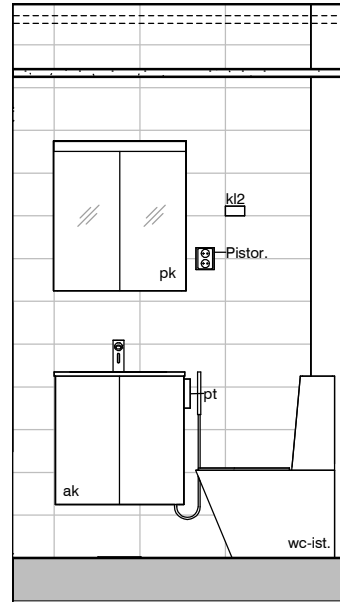

01h

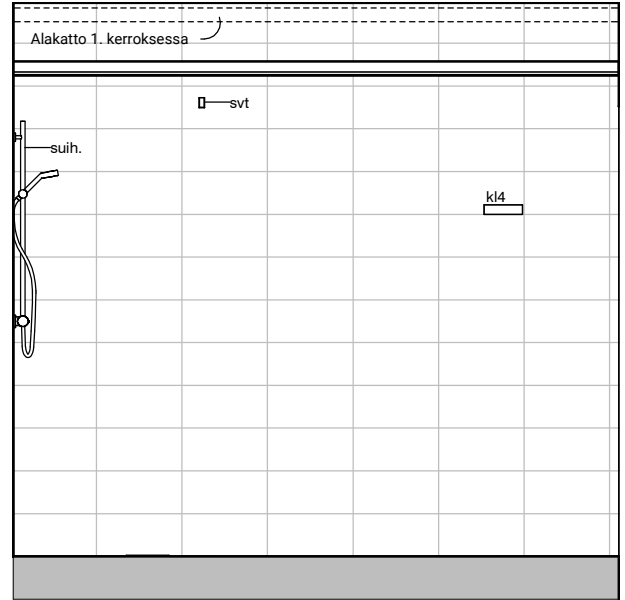
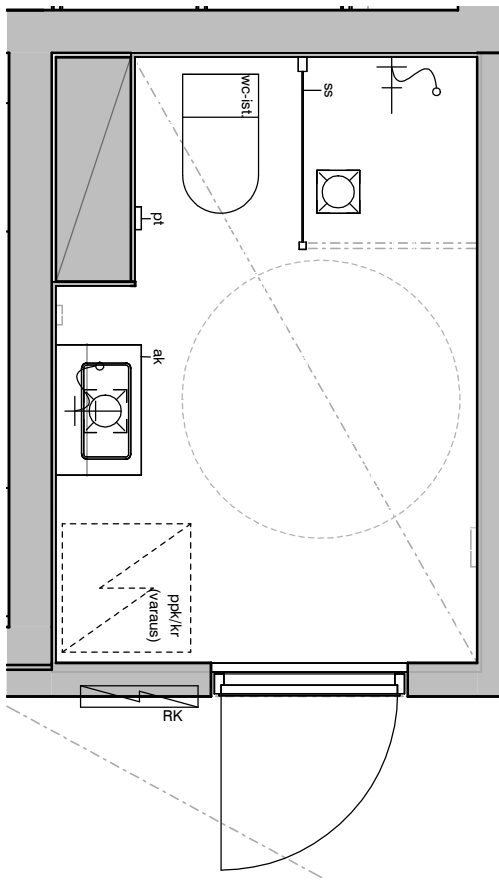

03b

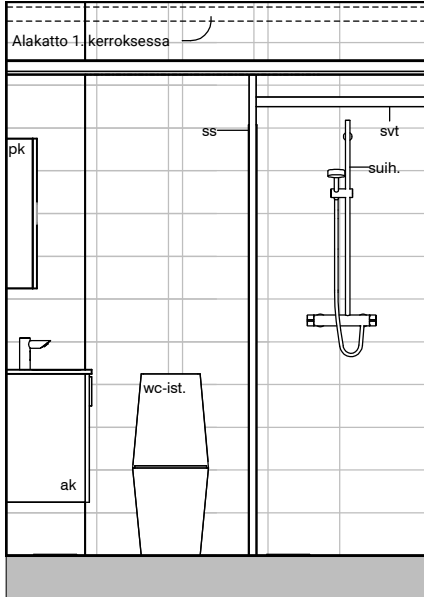

03a

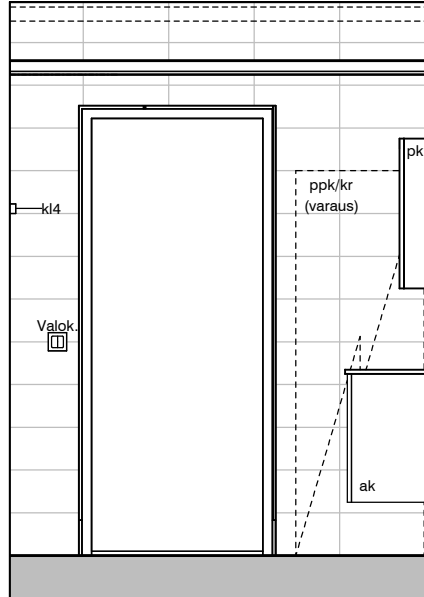

03c

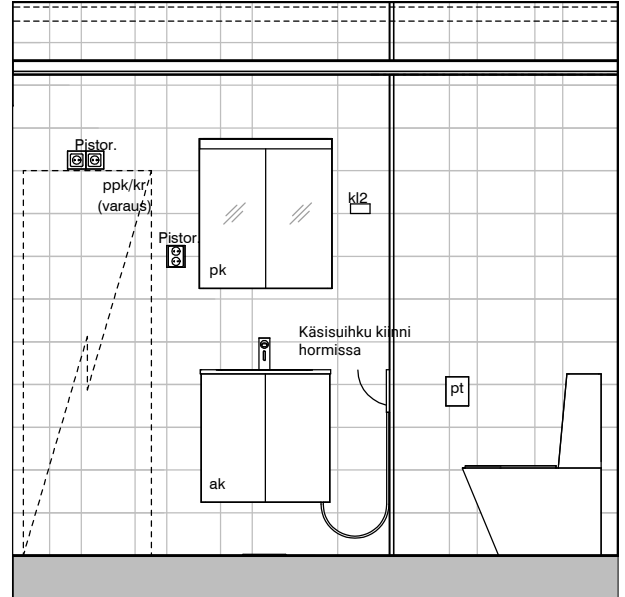

03d

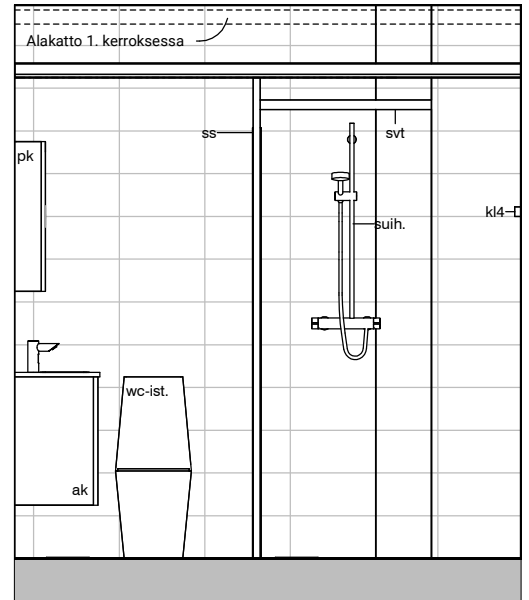
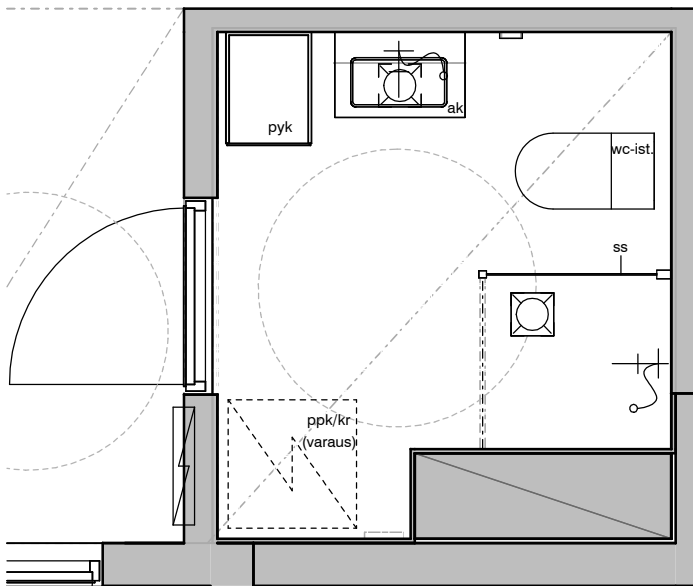

04a

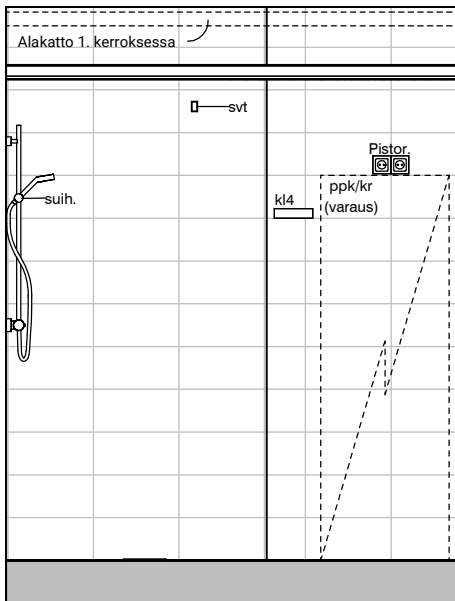

04b

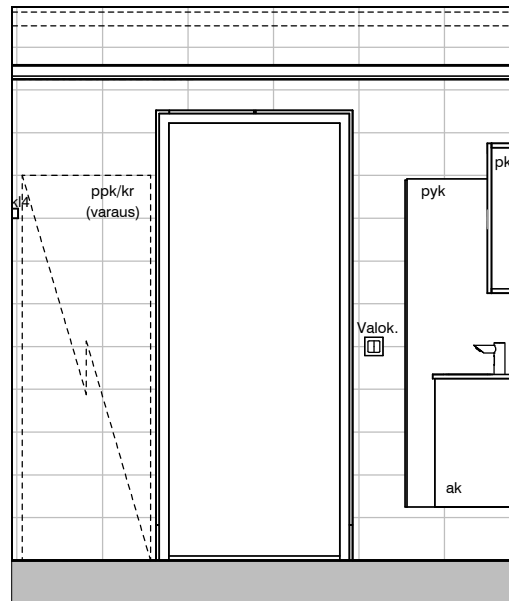

04c

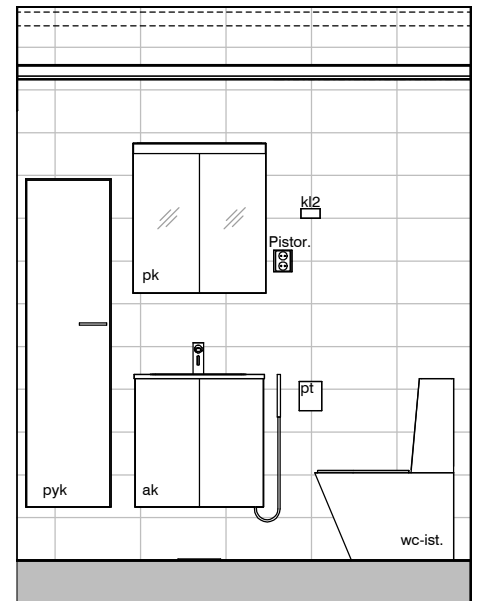

04d

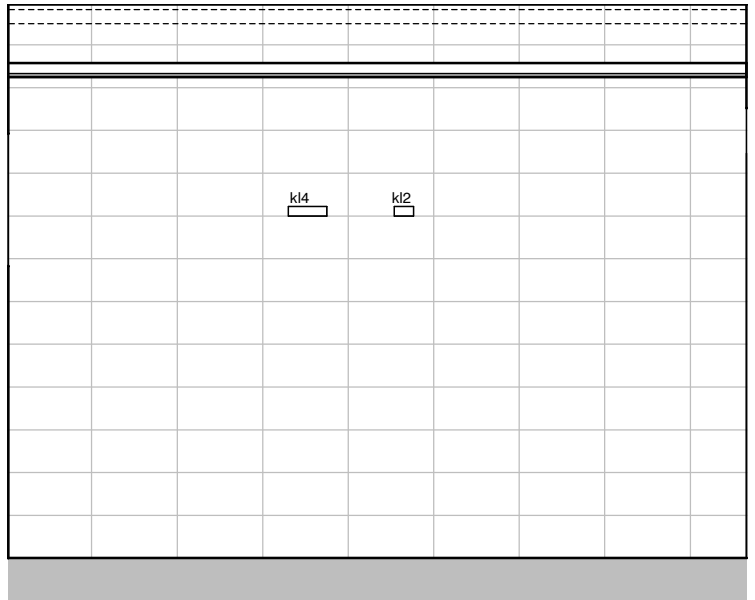
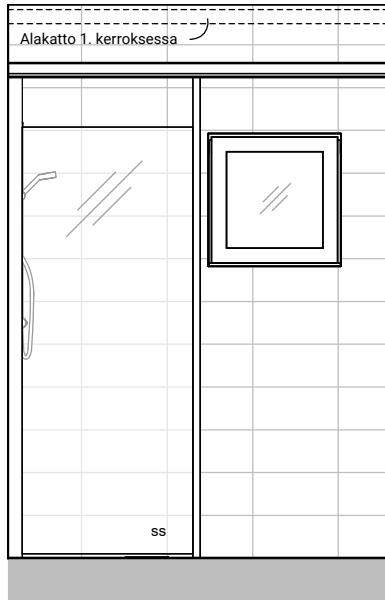
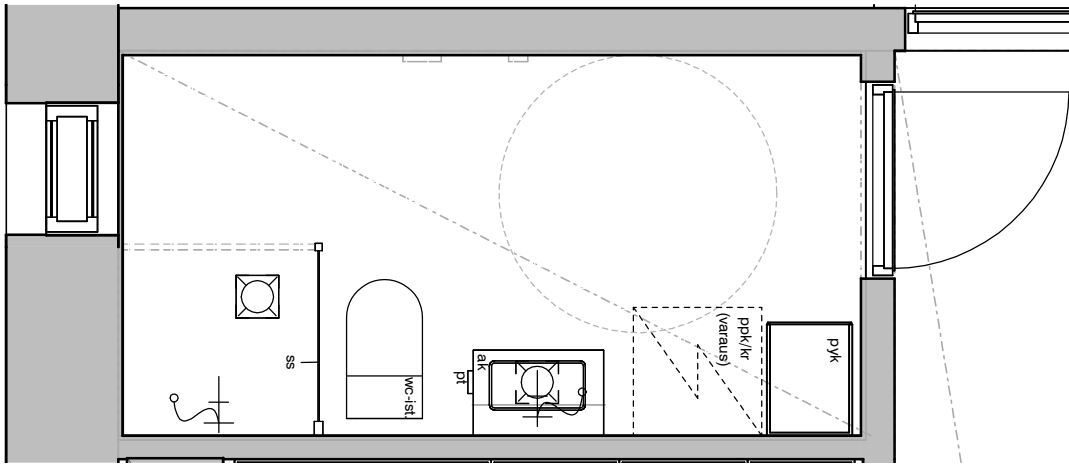

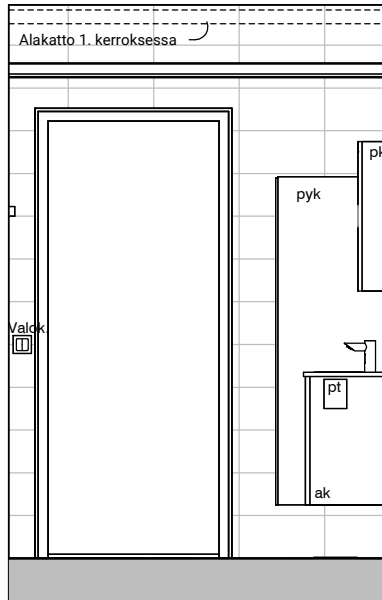

06c

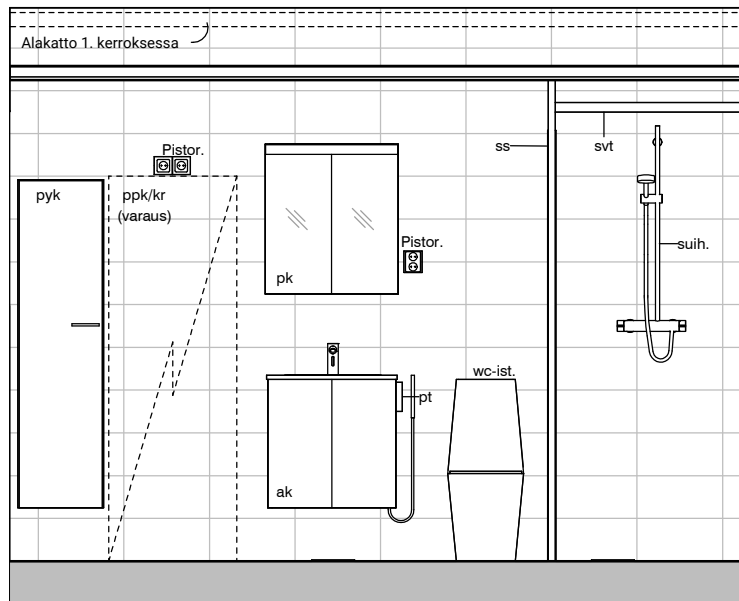

06d

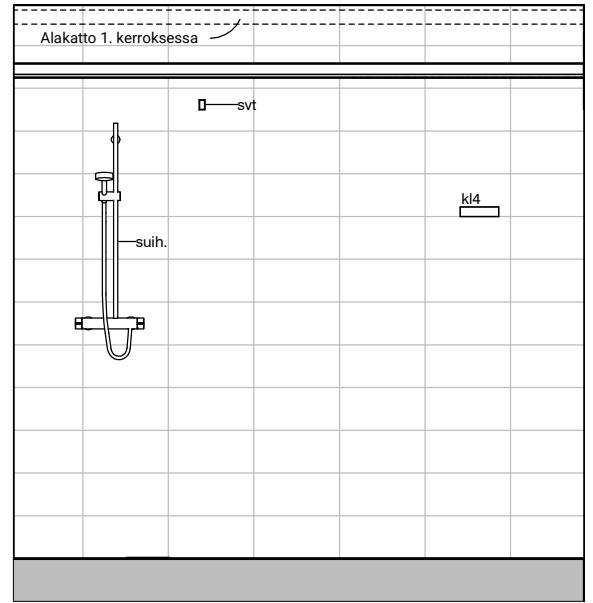
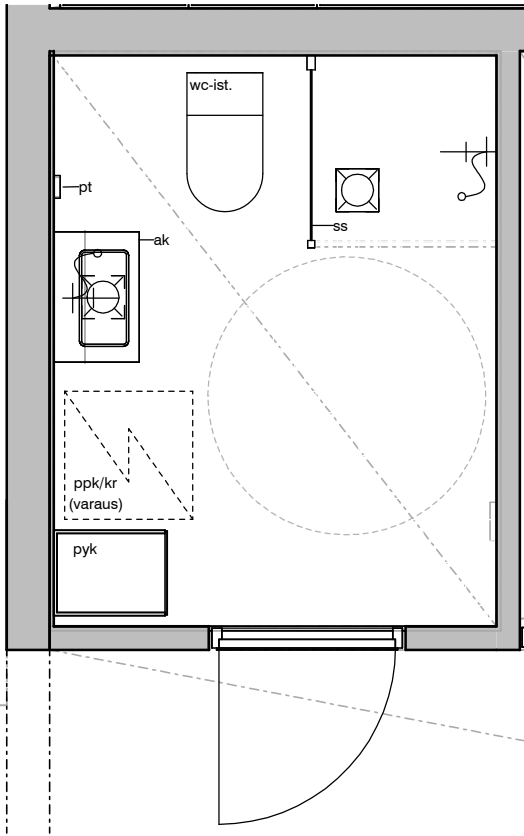

01b

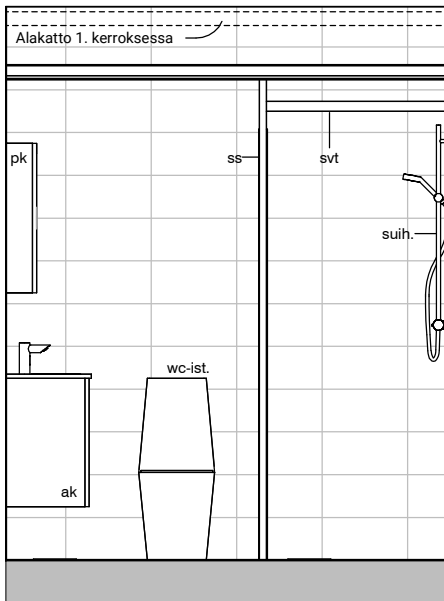

01a

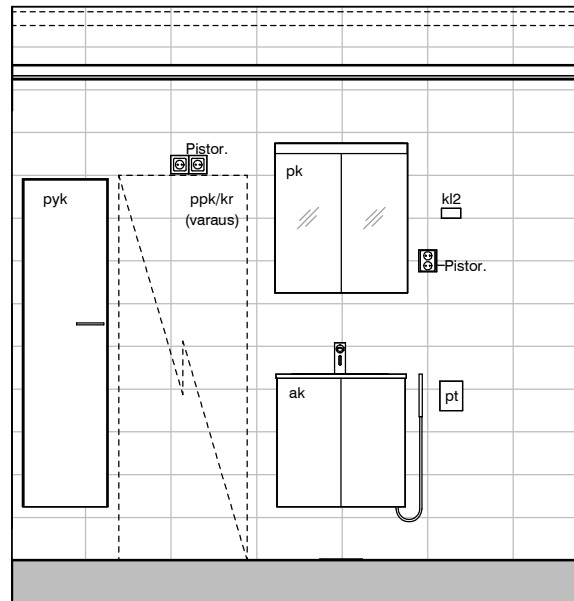

01d

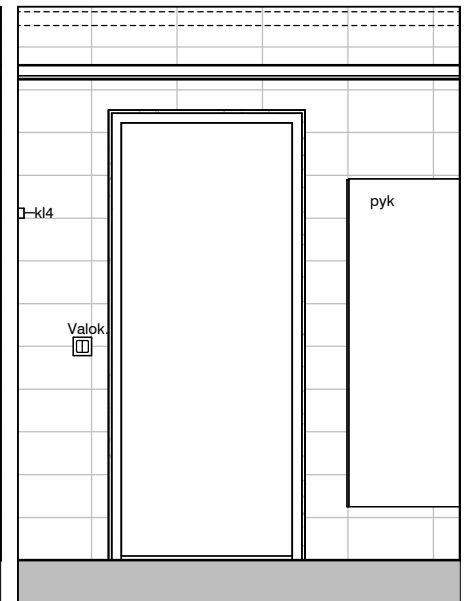

01c

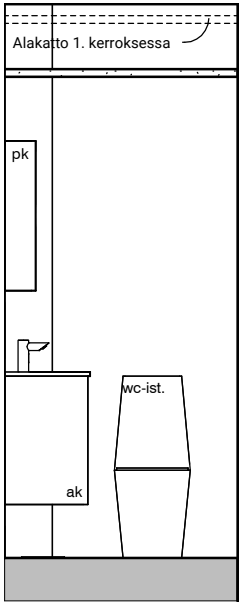
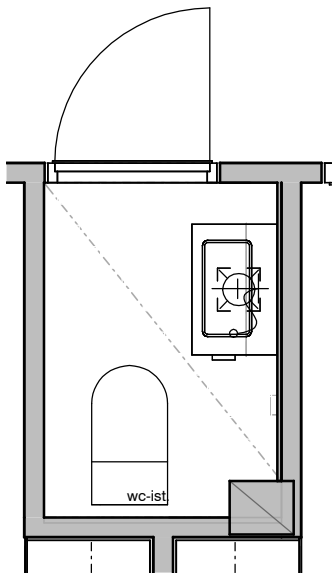

01e

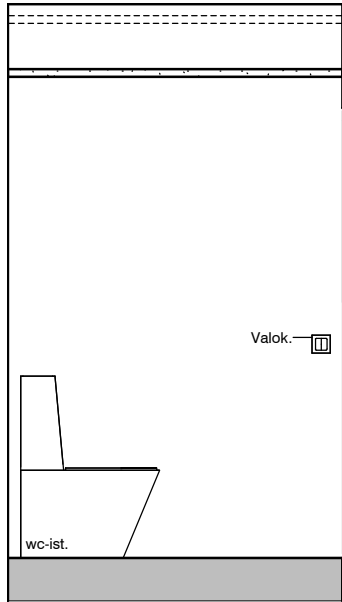

01f

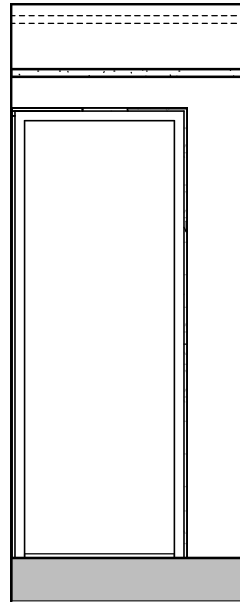

01g

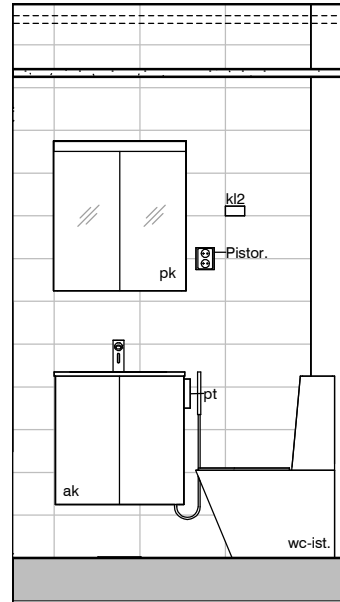

01h



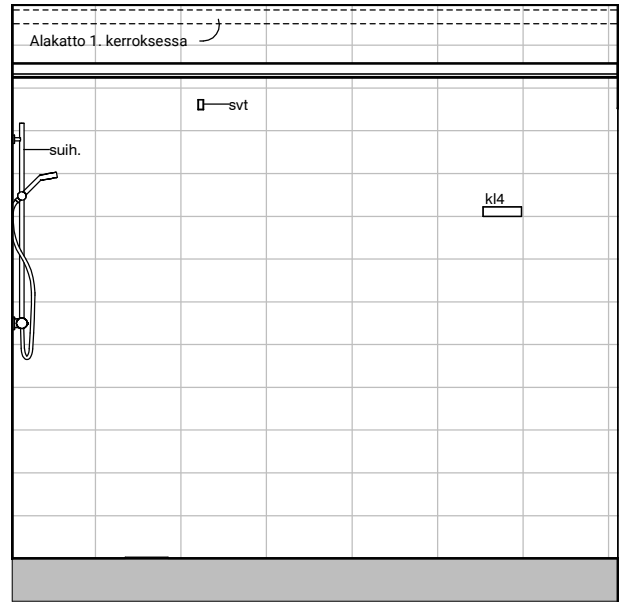
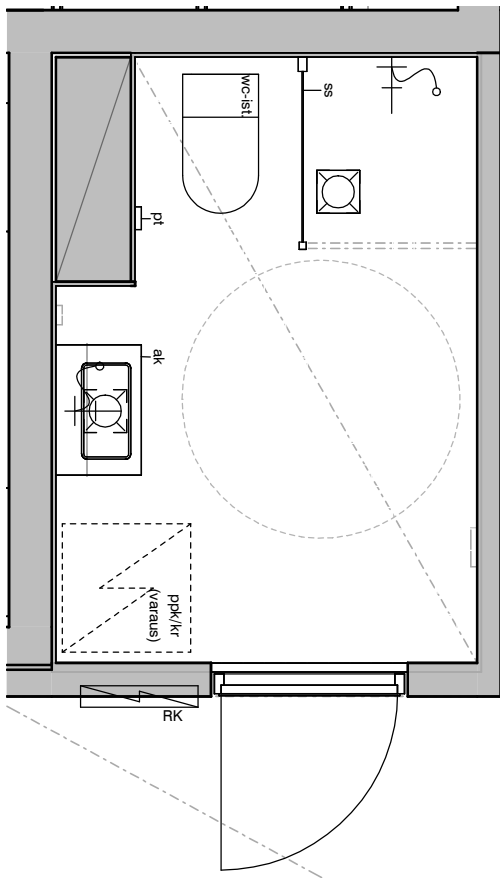

03b

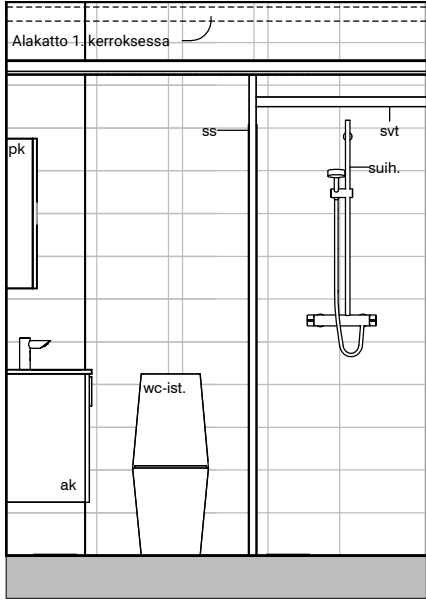

03a

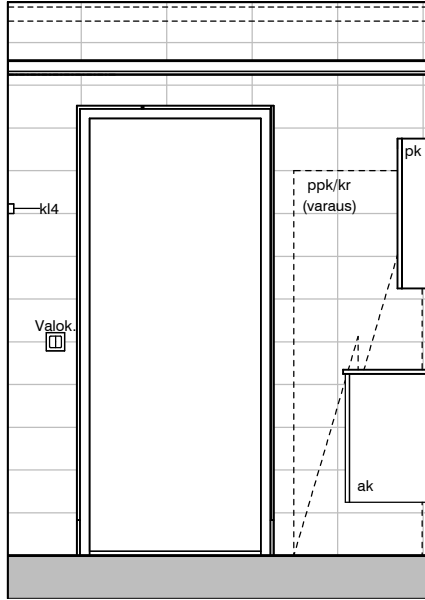

03c

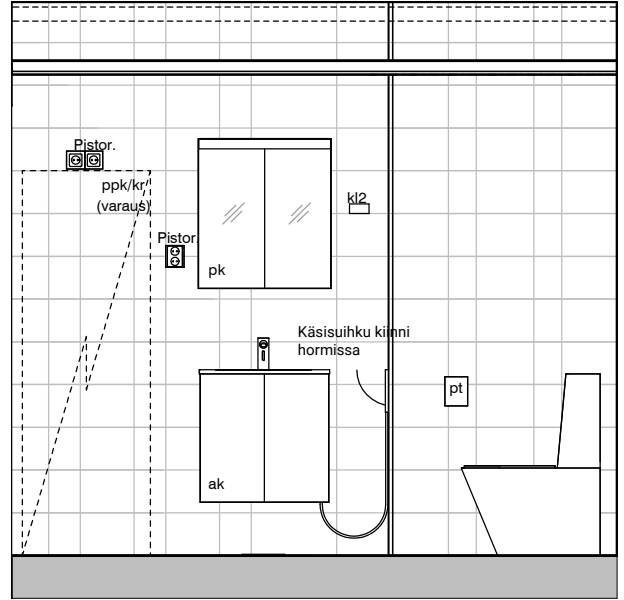

03d

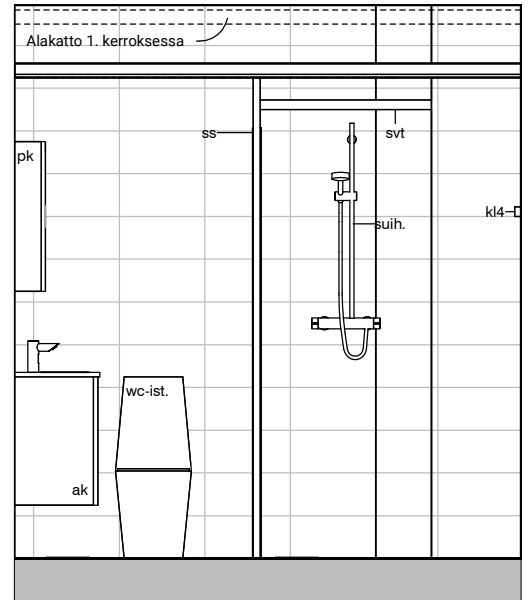
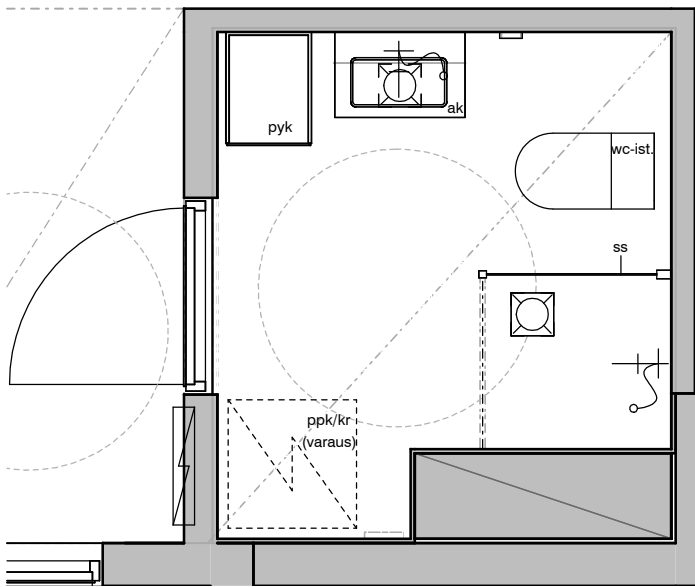

04a

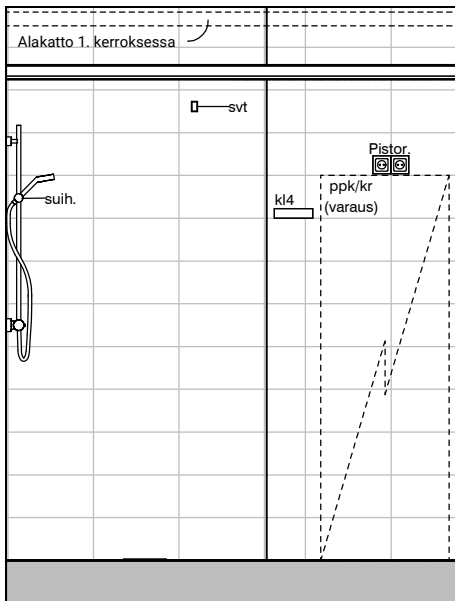

04b

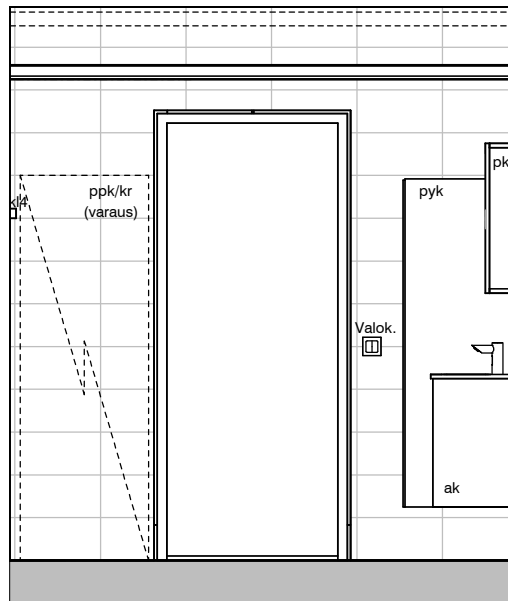

04c

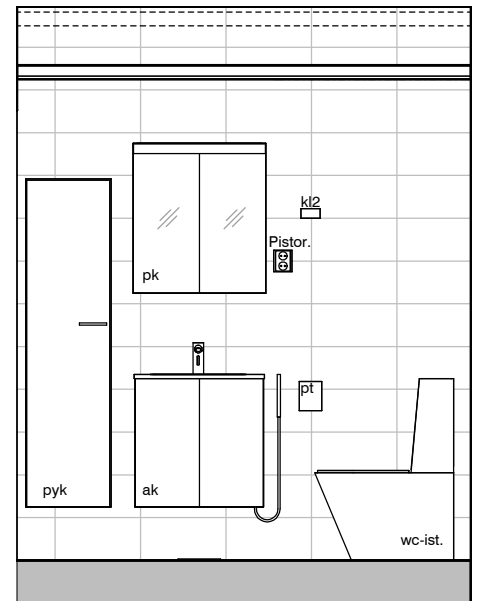

04d

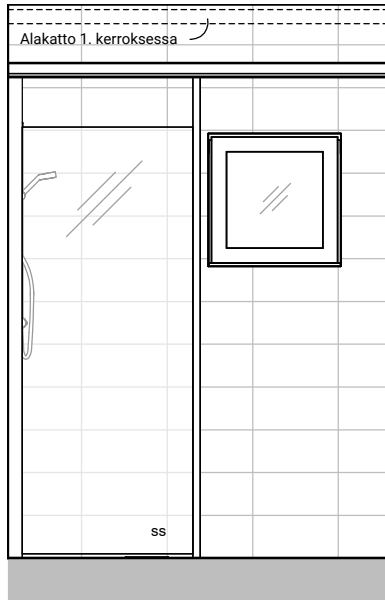
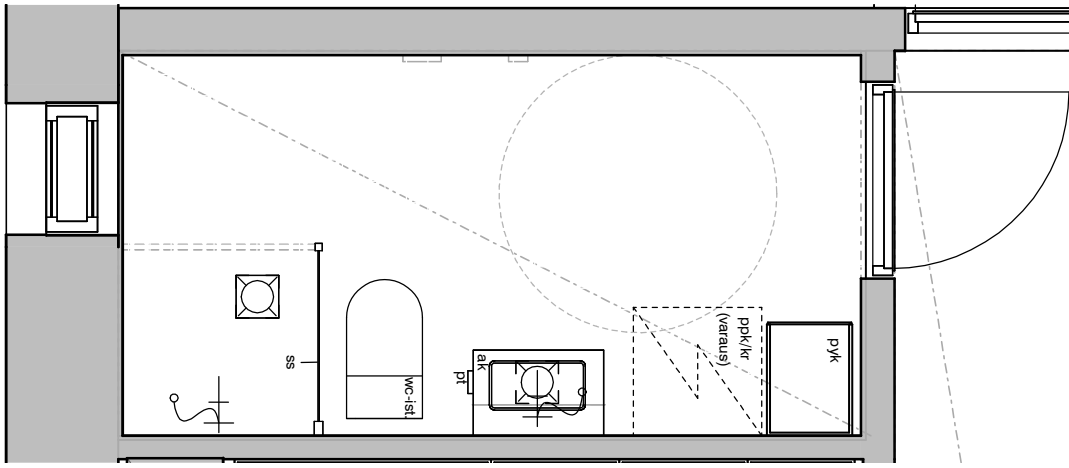

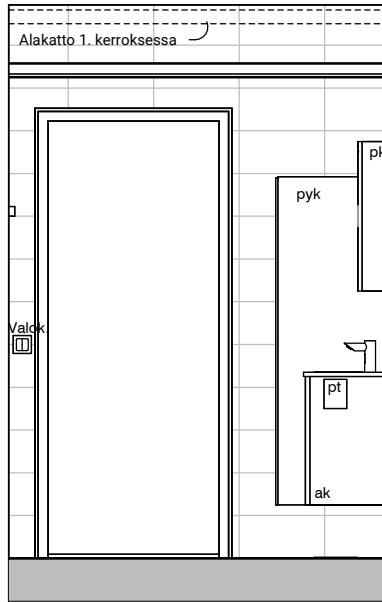

06c

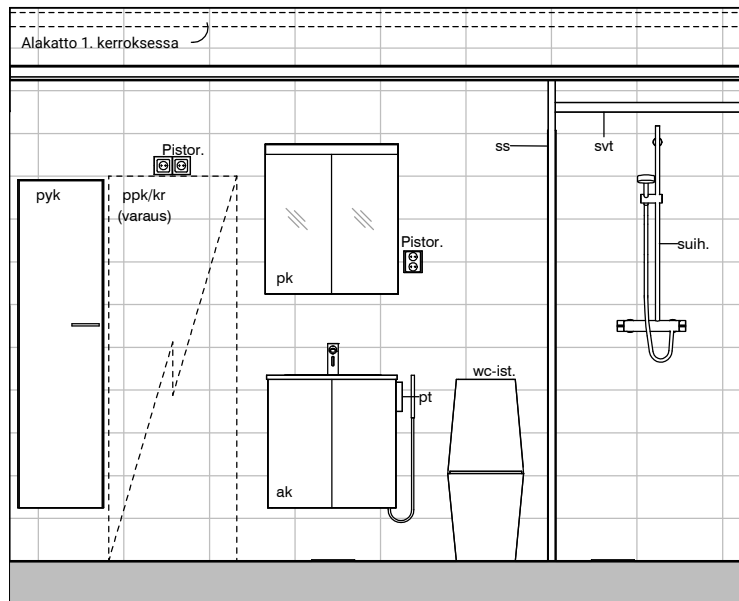

06d

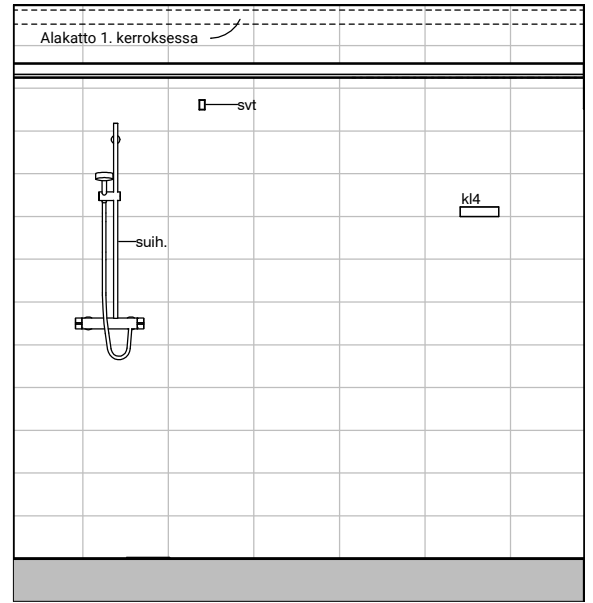
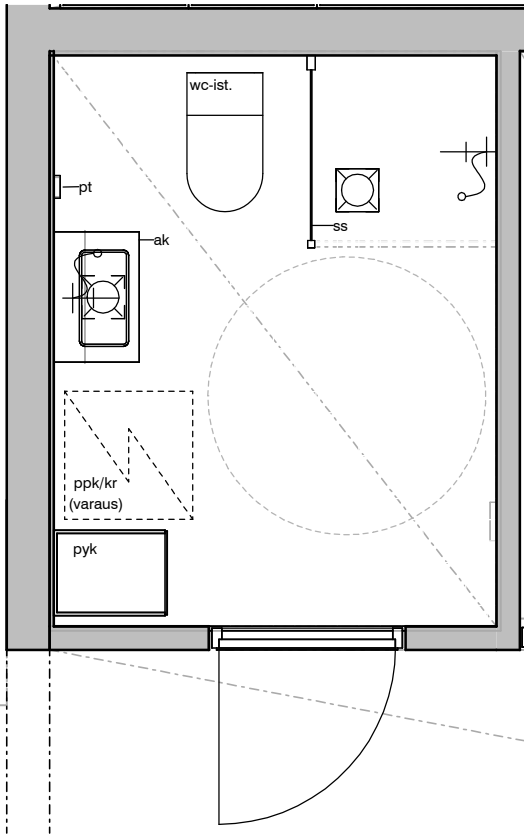

01b

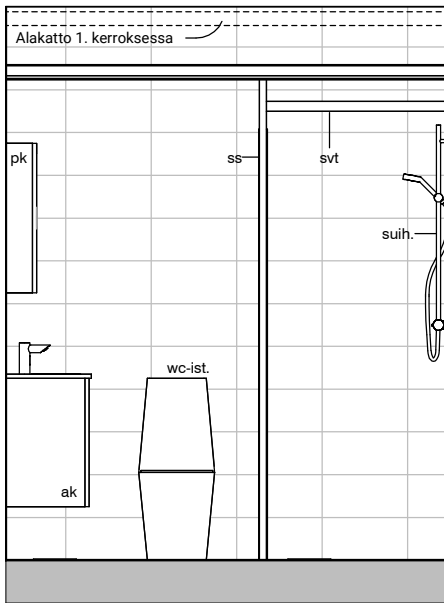

01a

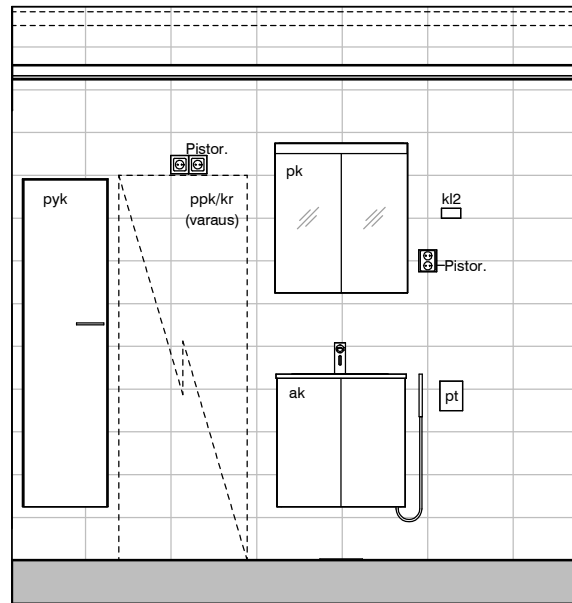

01d

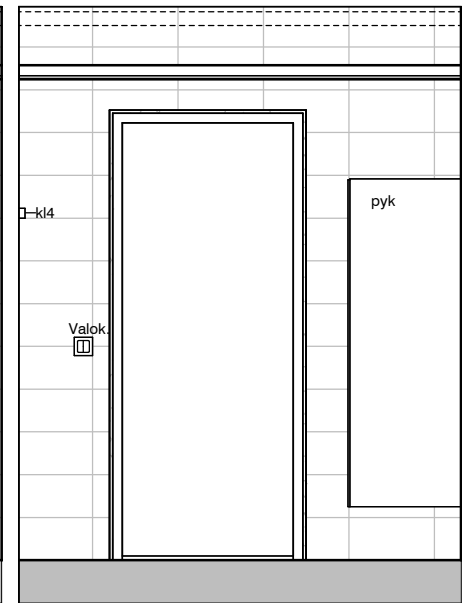

01c

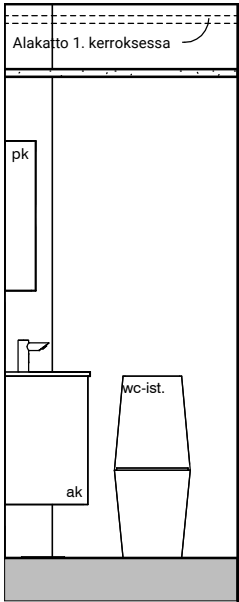
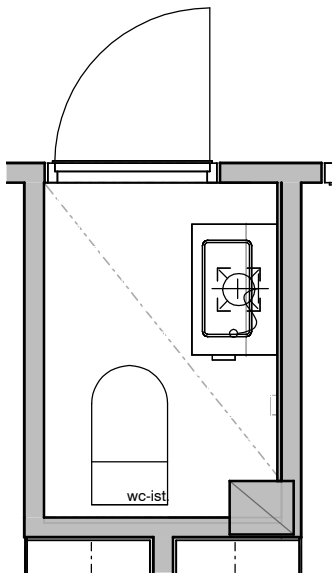

01e

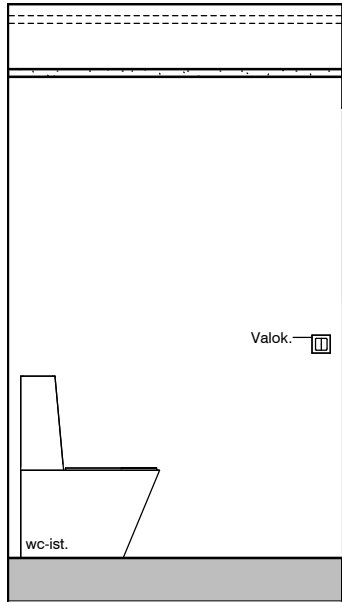

01f

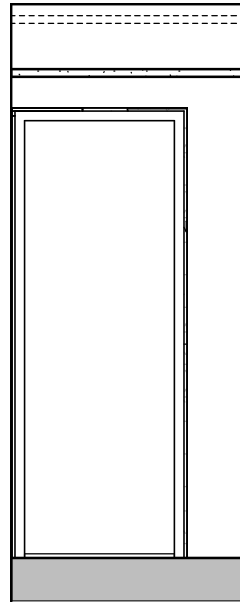

01g

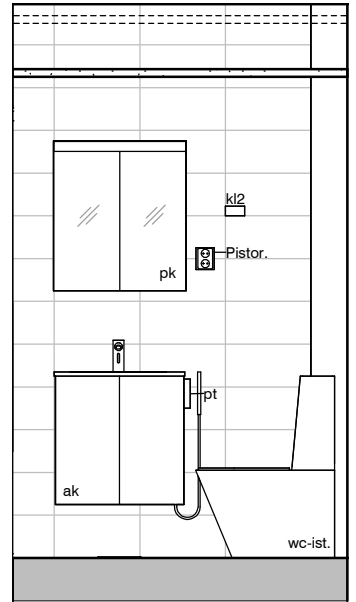

01h

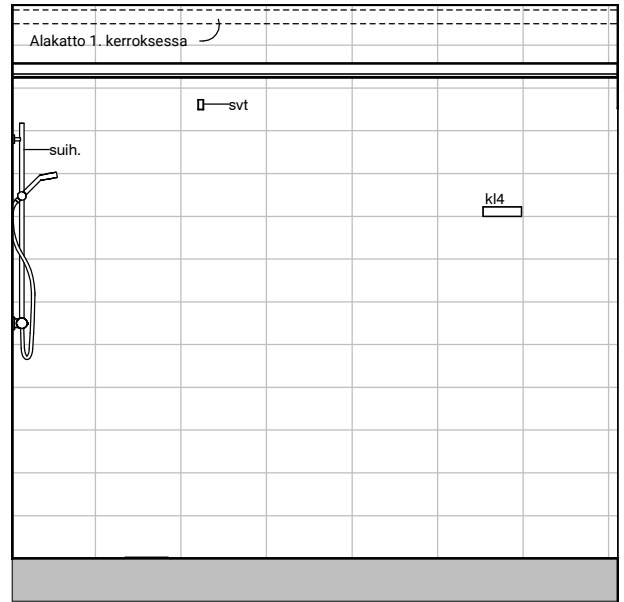
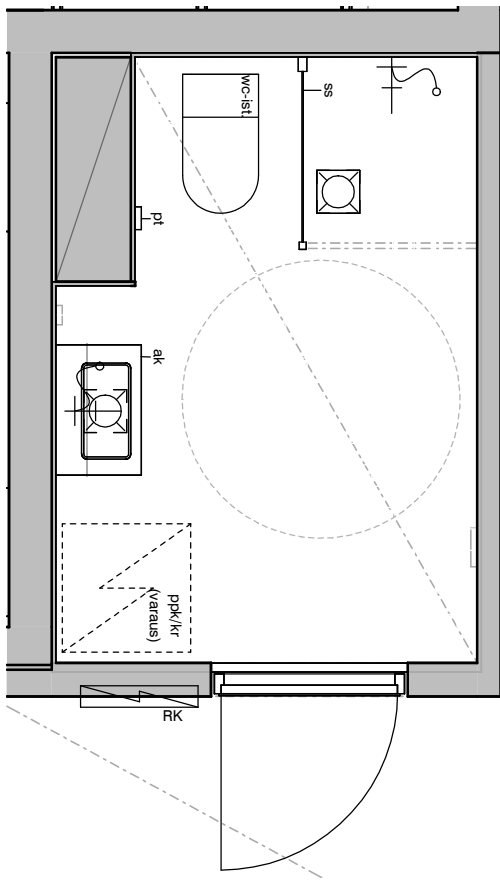

03b

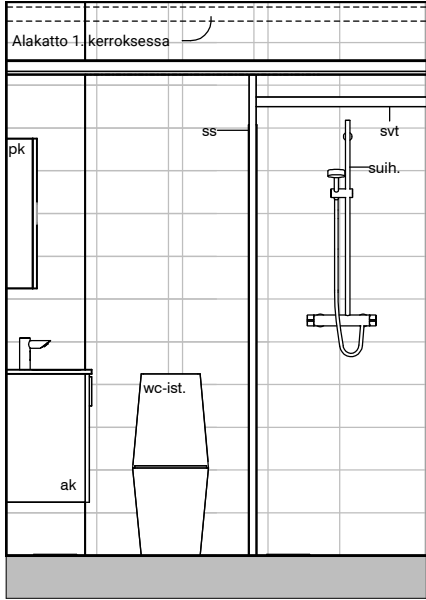

03a

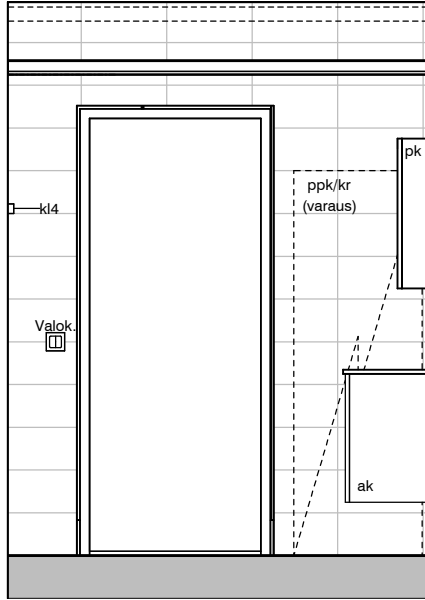

03c

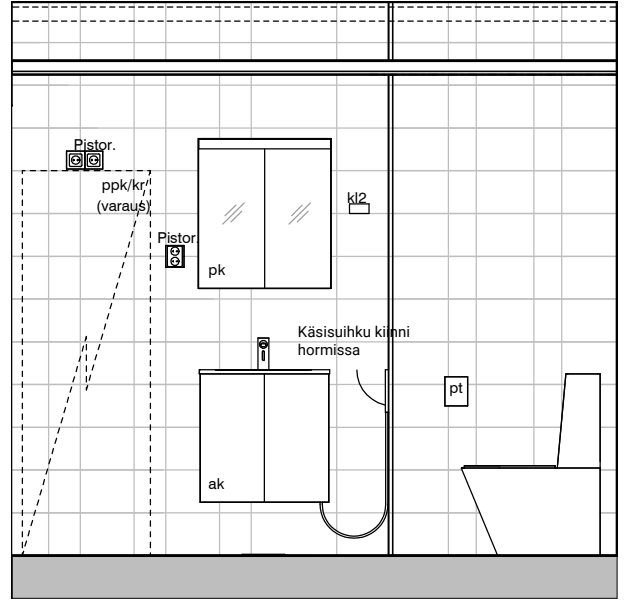

03d

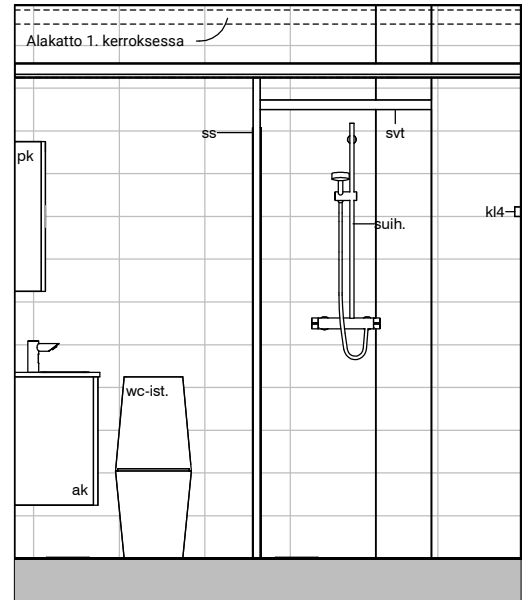
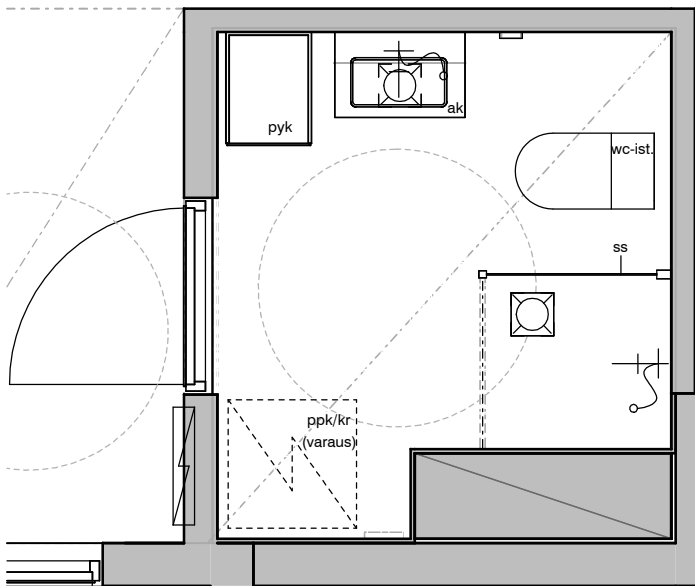

04a

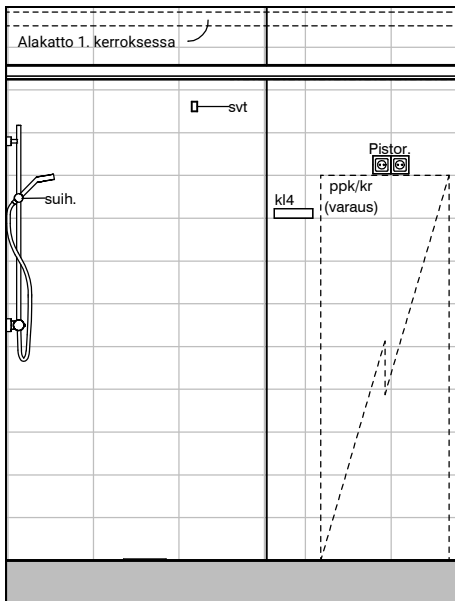

04b

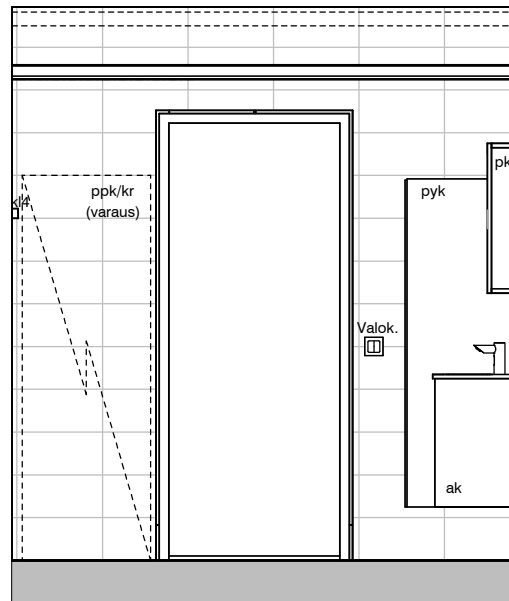

04c

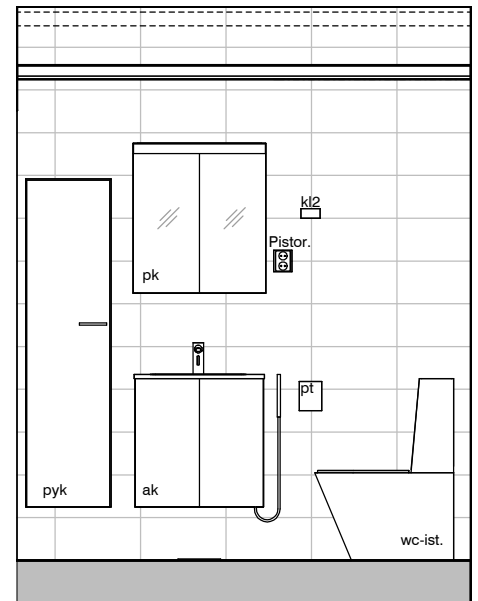

04d



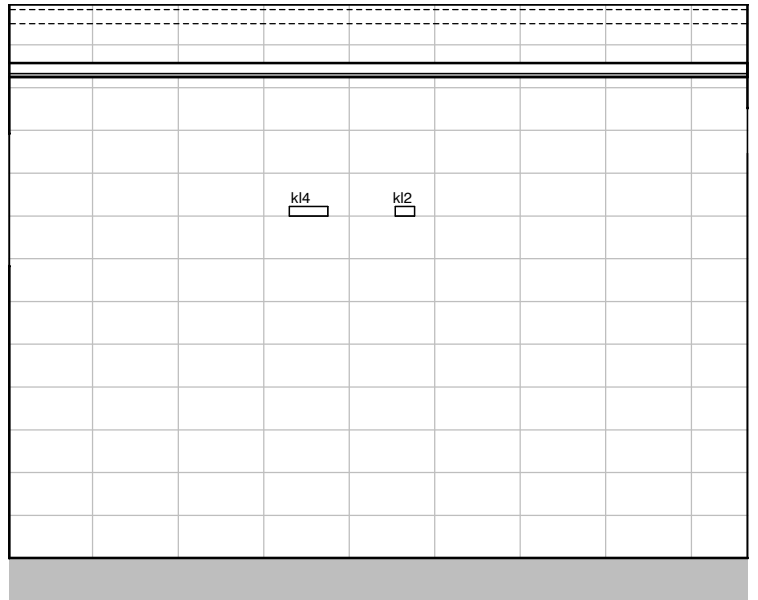
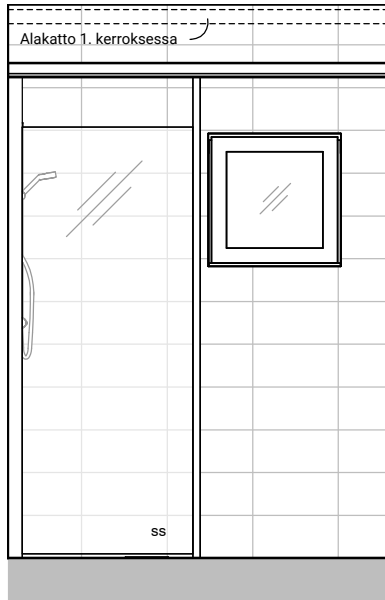
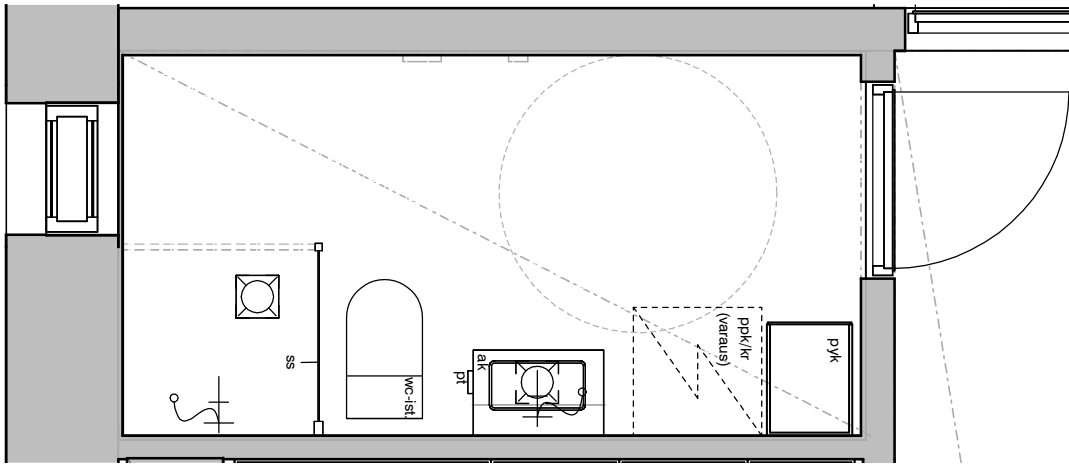

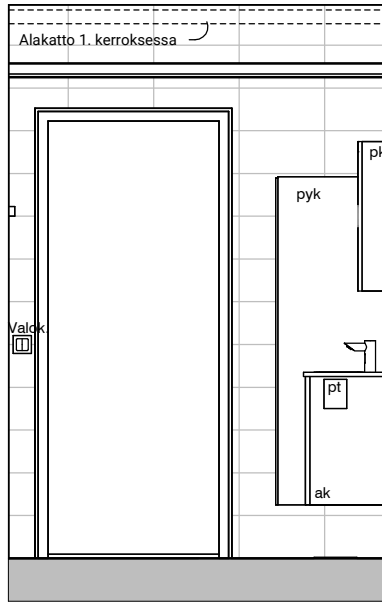

06c

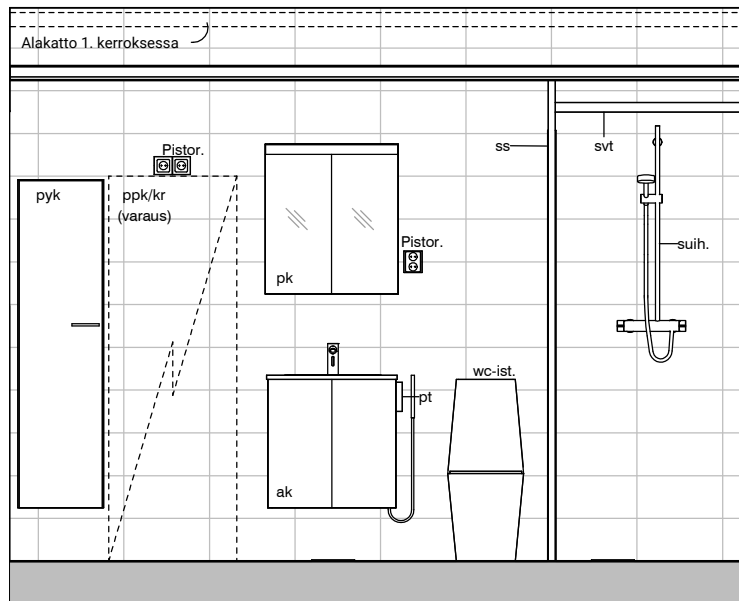

06d

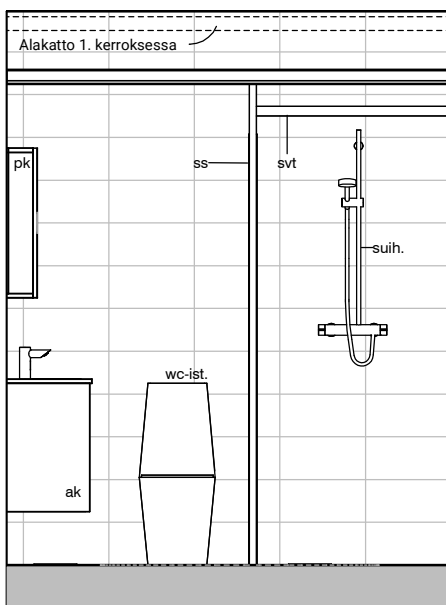
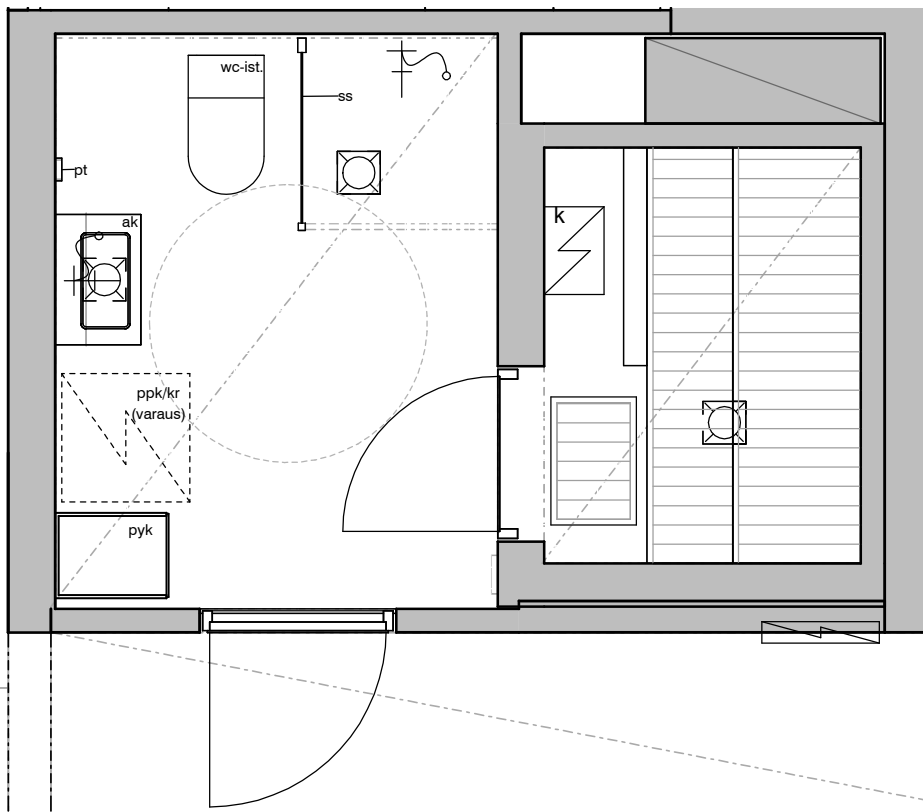

02a

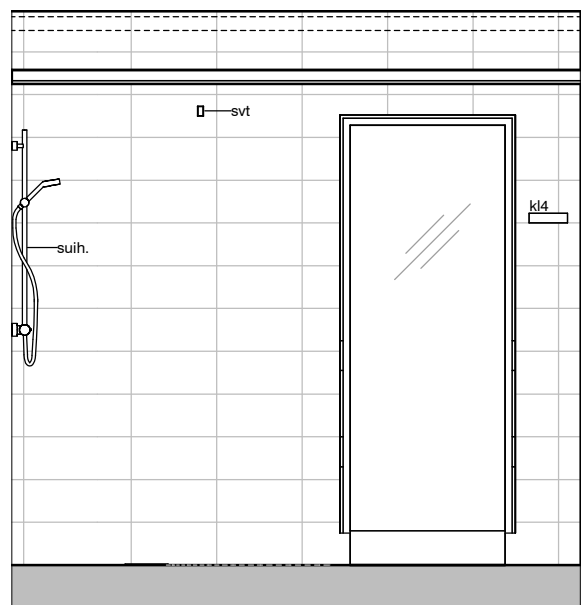

02b

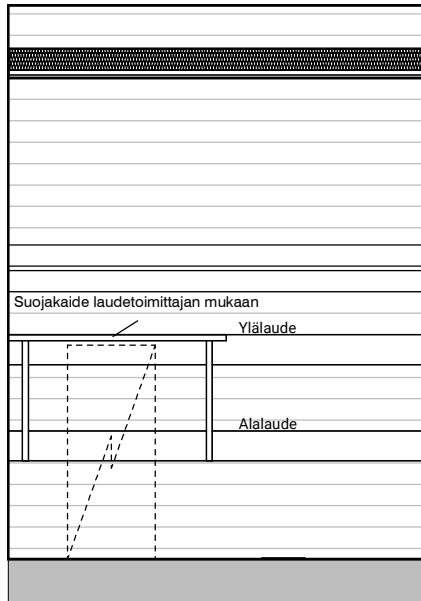

02e

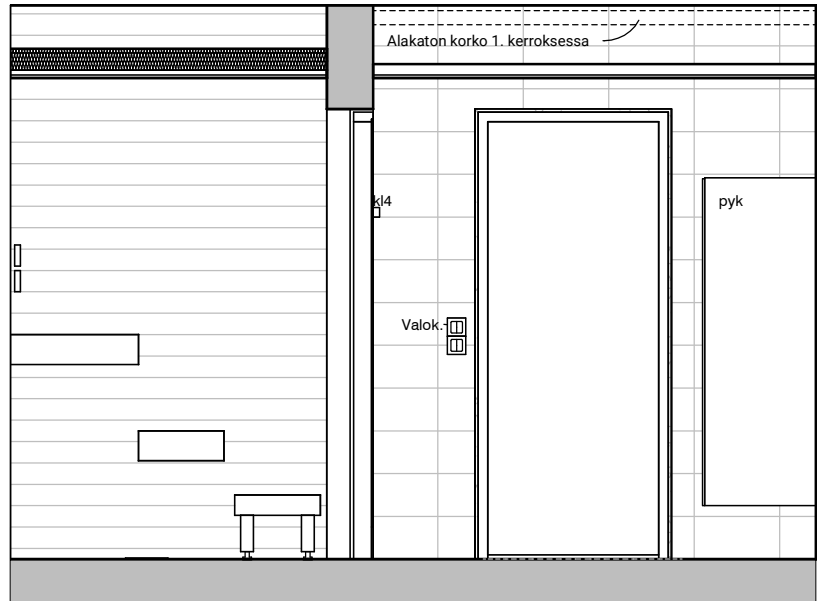

02c

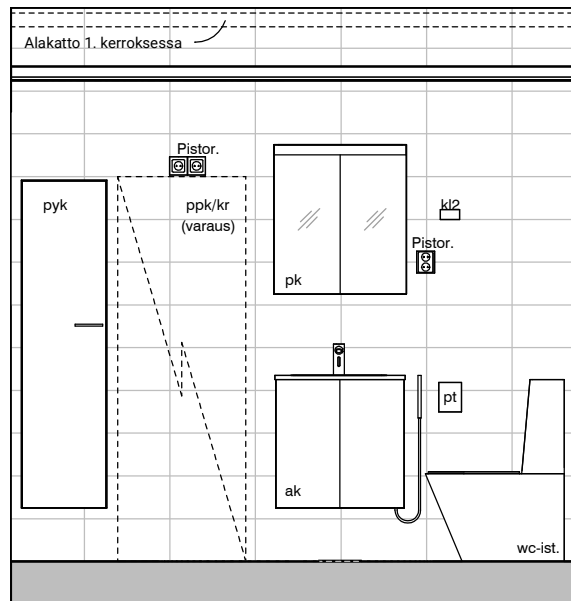

02d

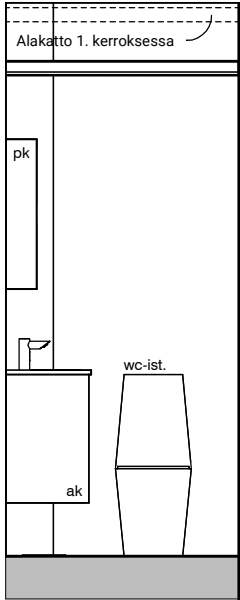
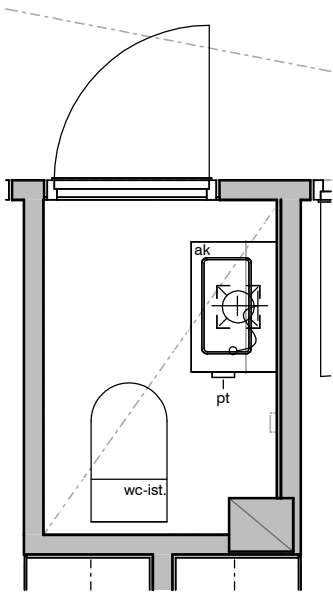

02f

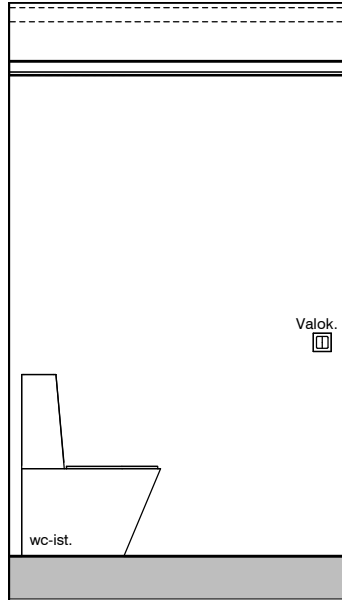

02g

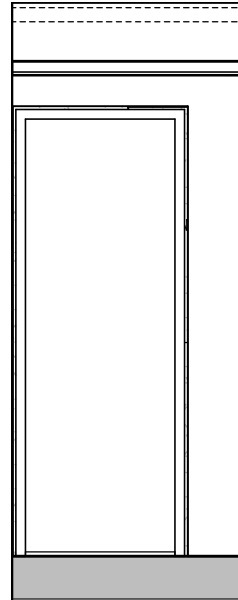

02h

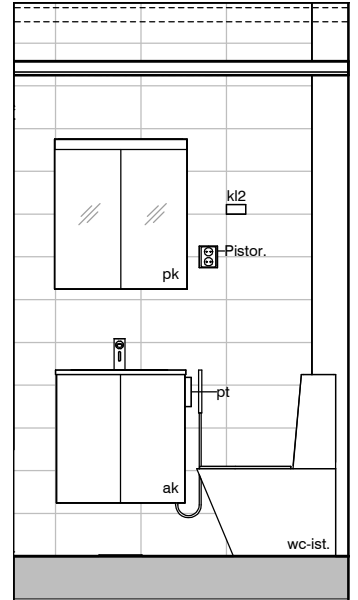

02i

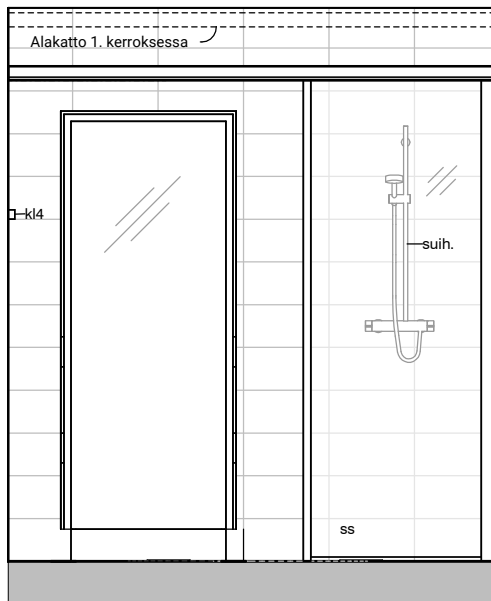
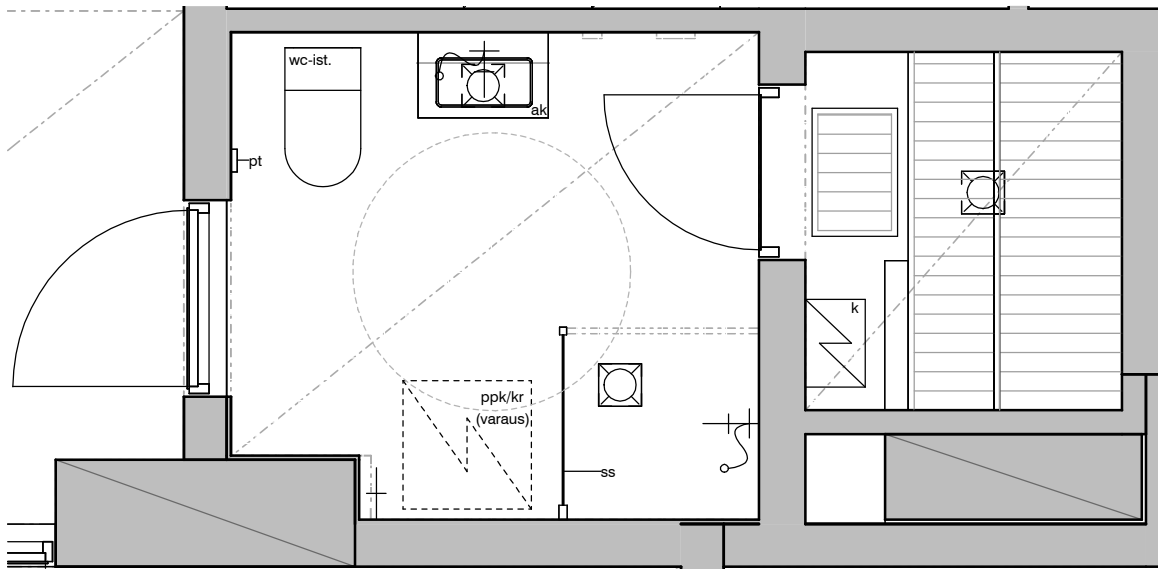

05a

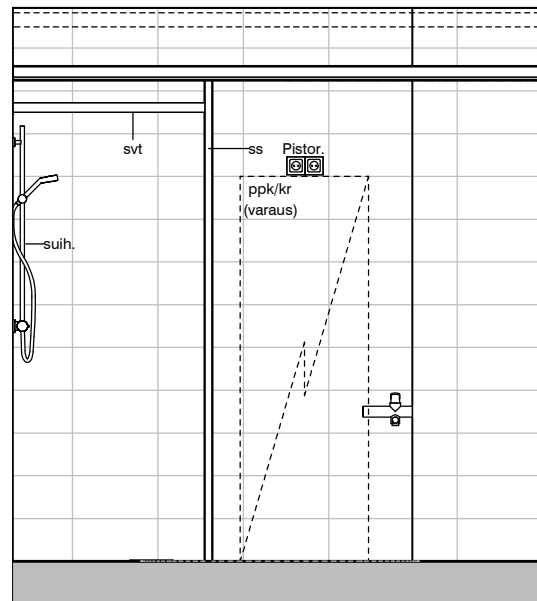

05b

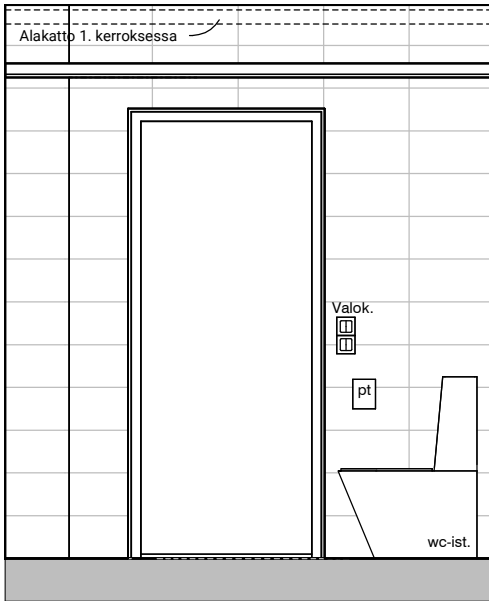

05c

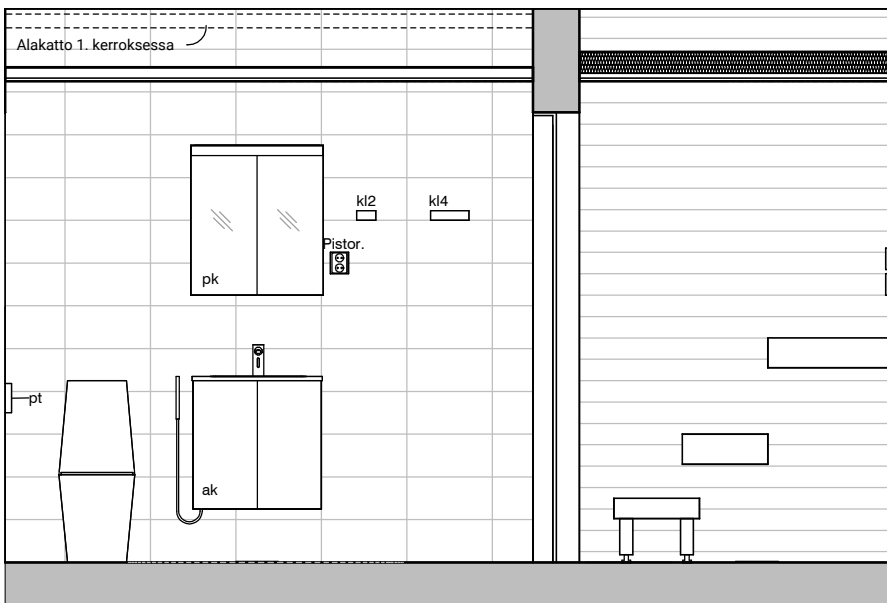

05d

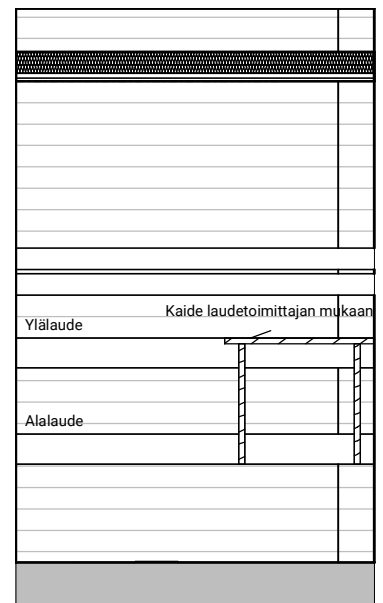

05e

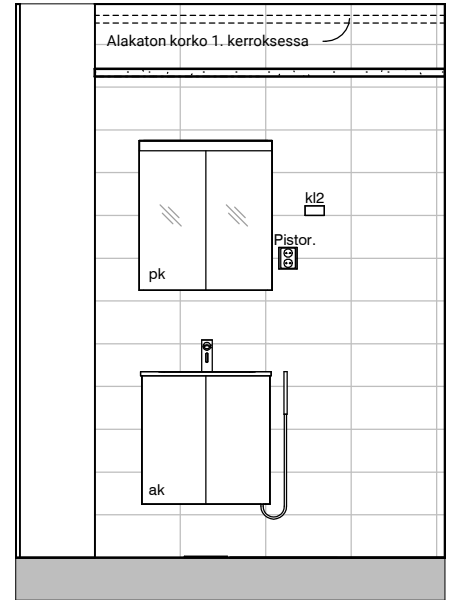
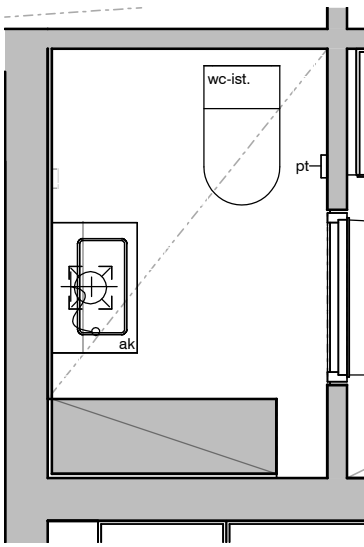

05f

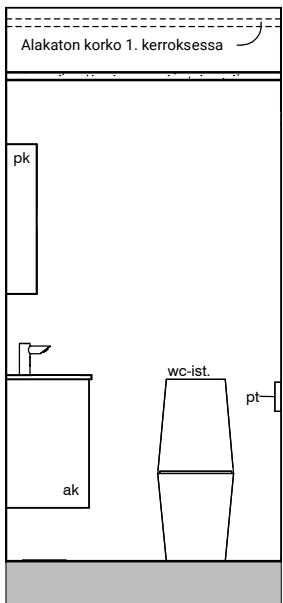

05g

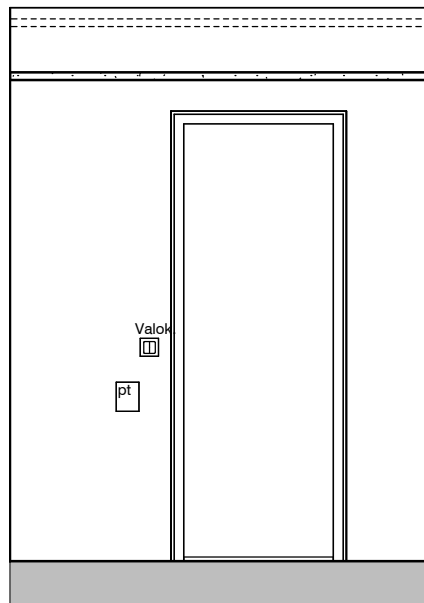

05h

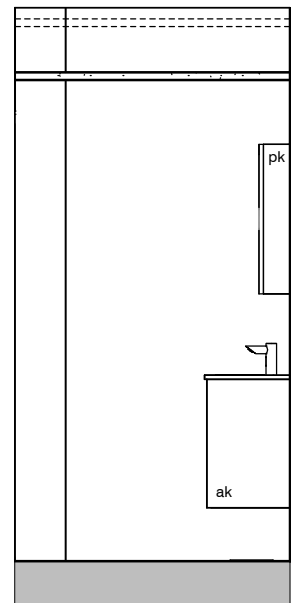

05i



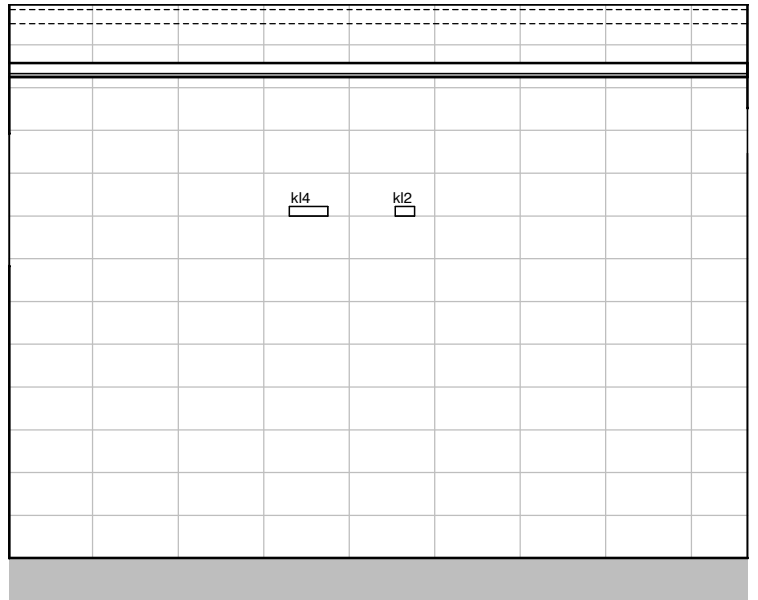
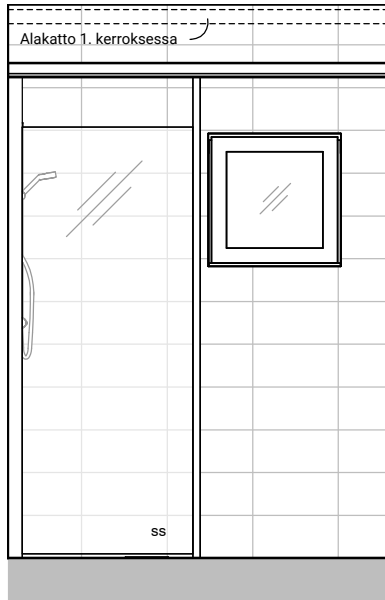
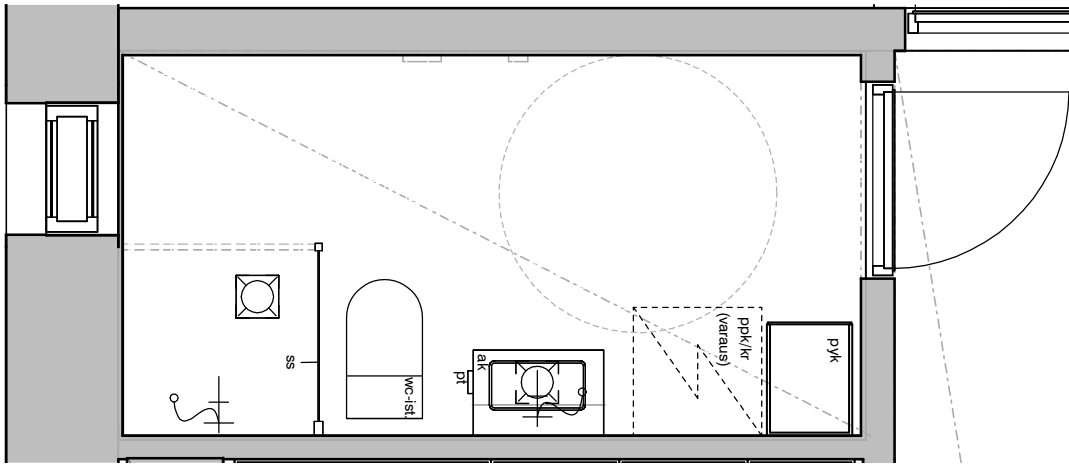

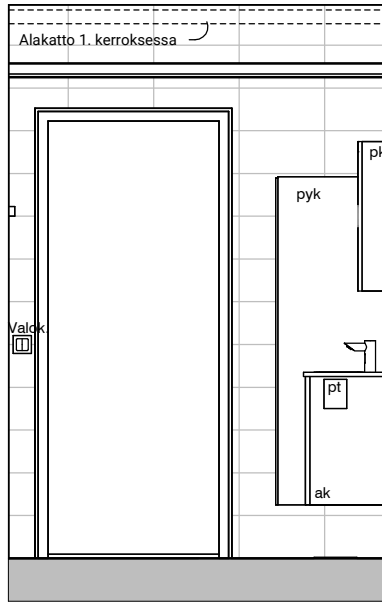

06c

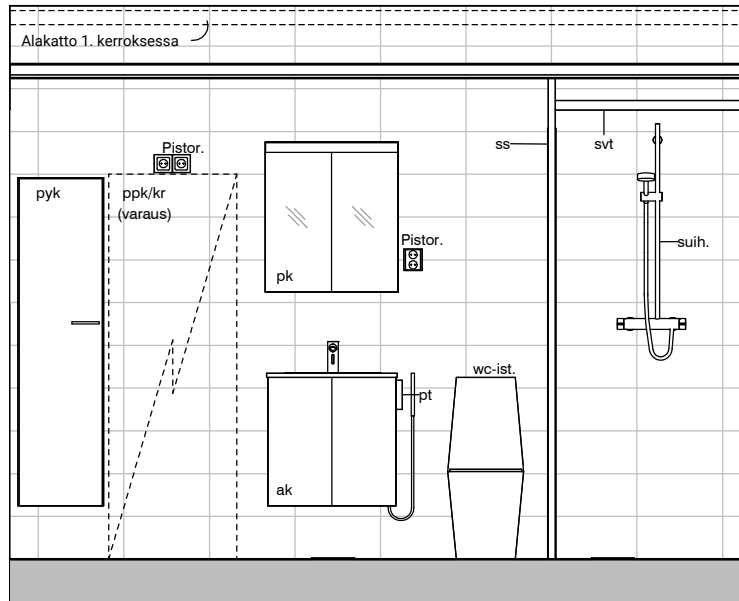

06d