

06c

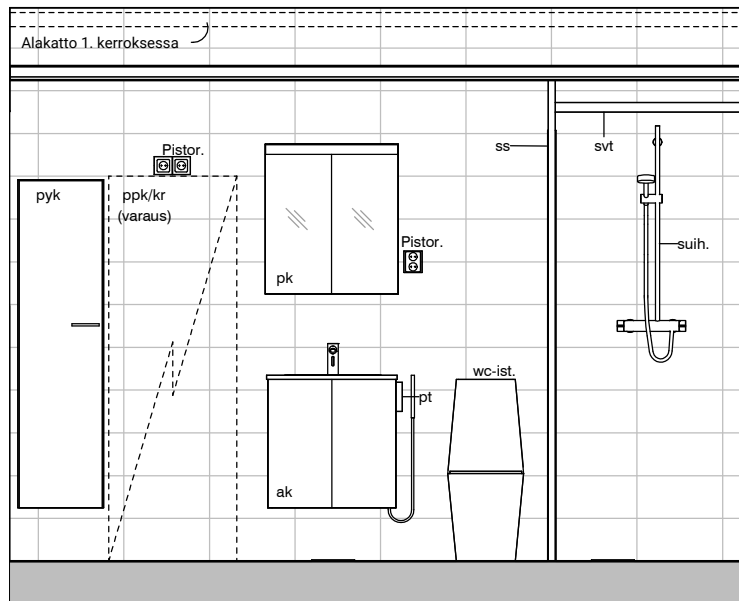

06d

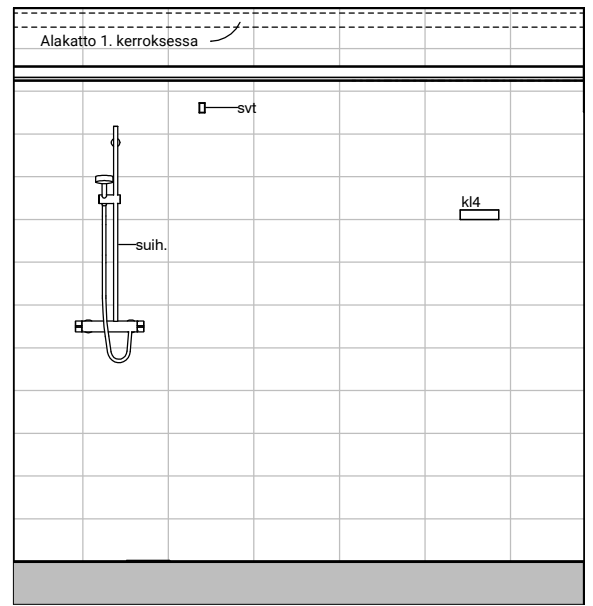
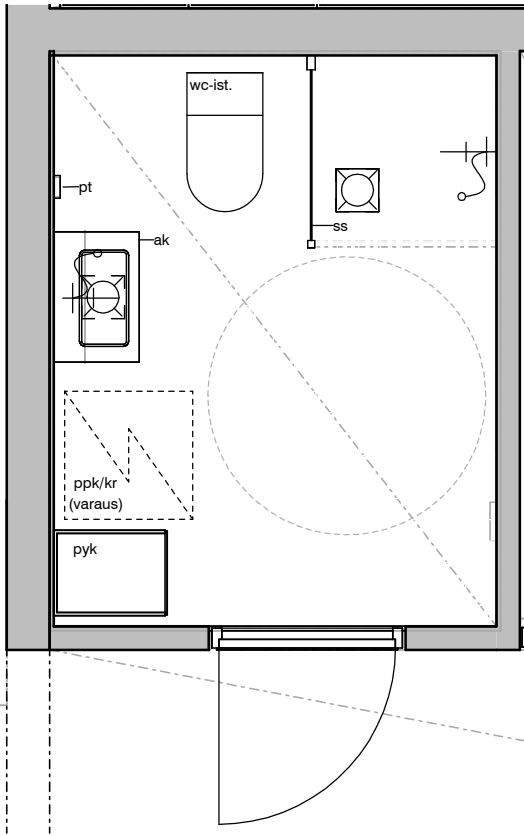

01b

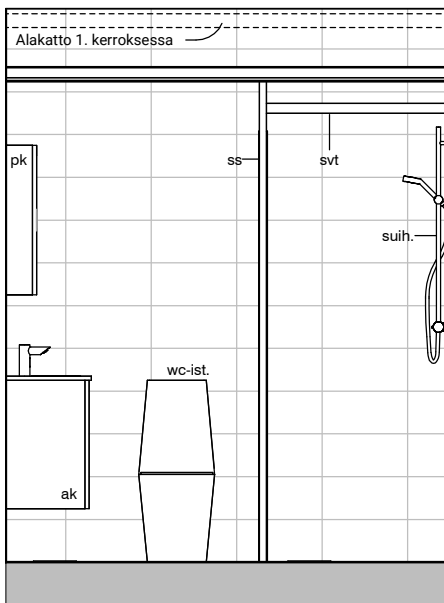

01a

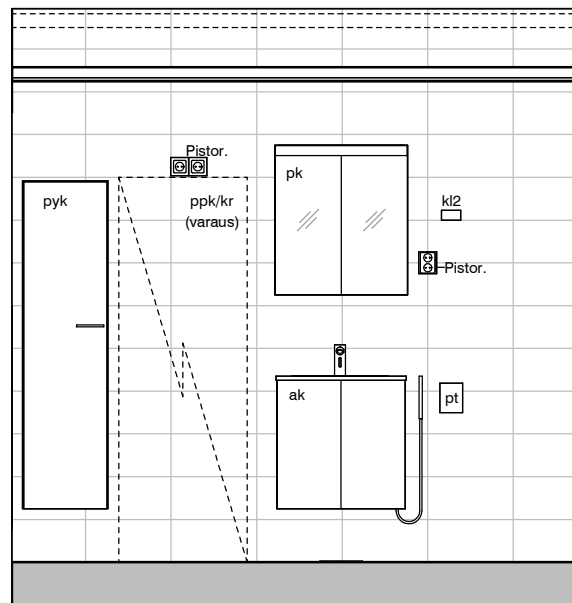

01d

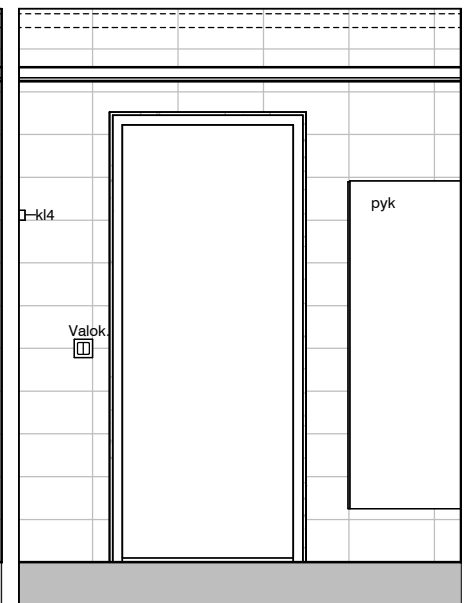

01c

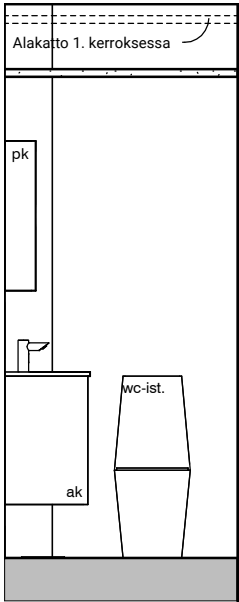
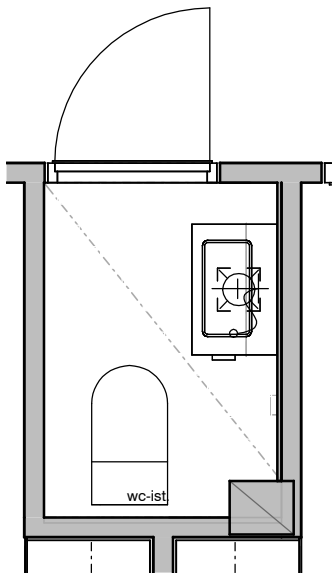

01e

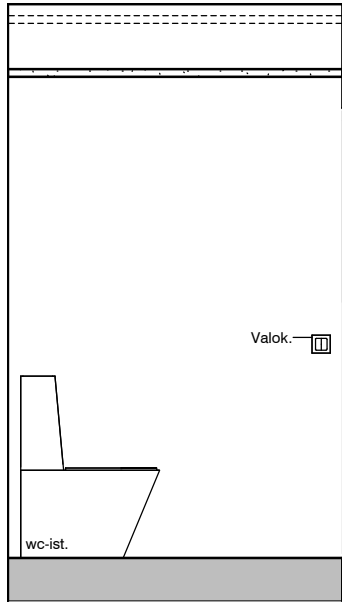

01f

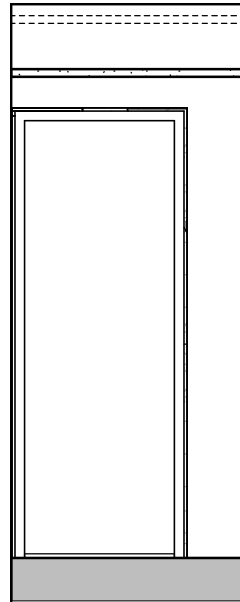

01g

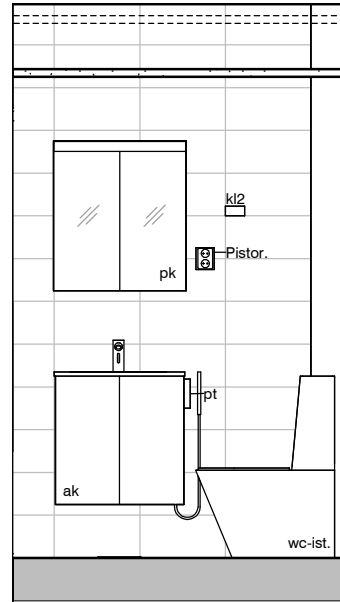

01h

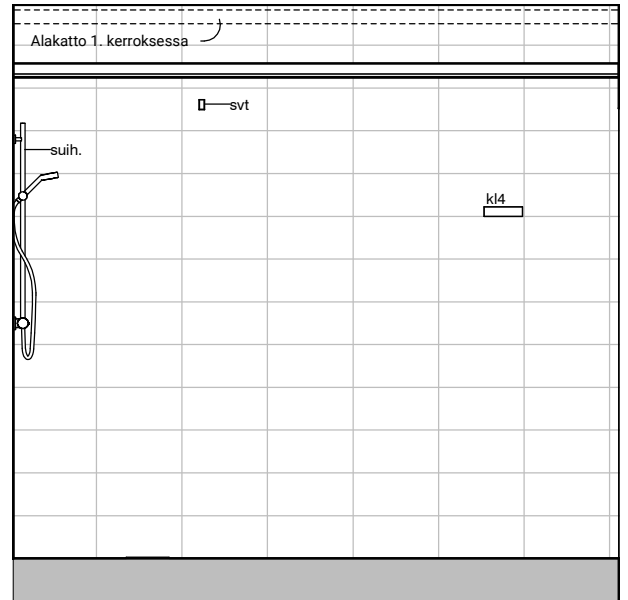
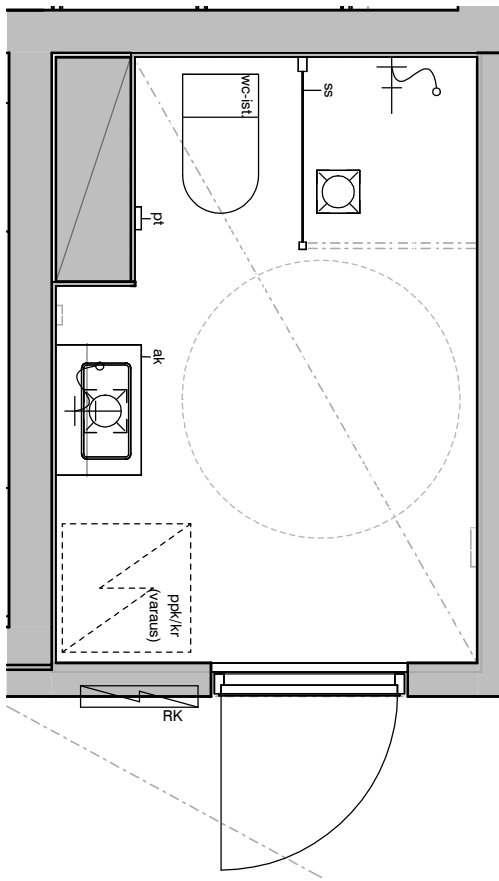

03b

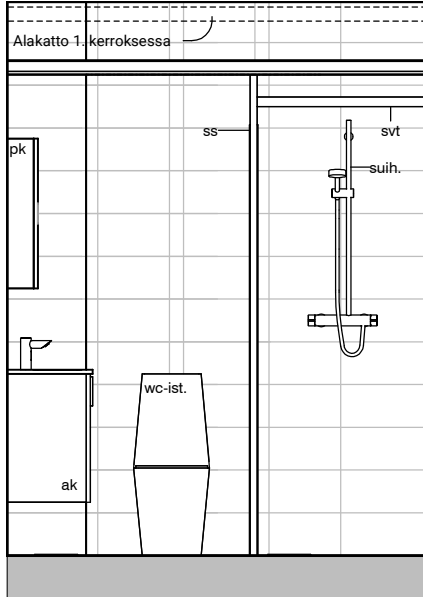

03a

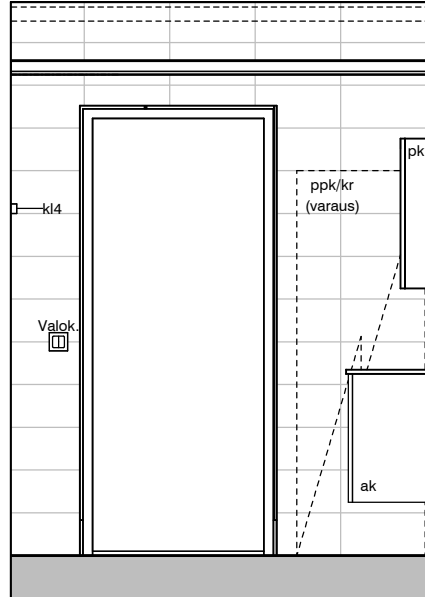

03c

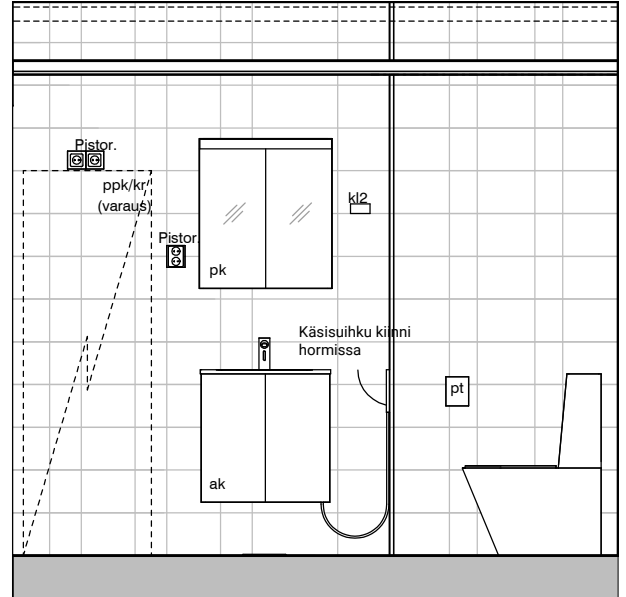

03d

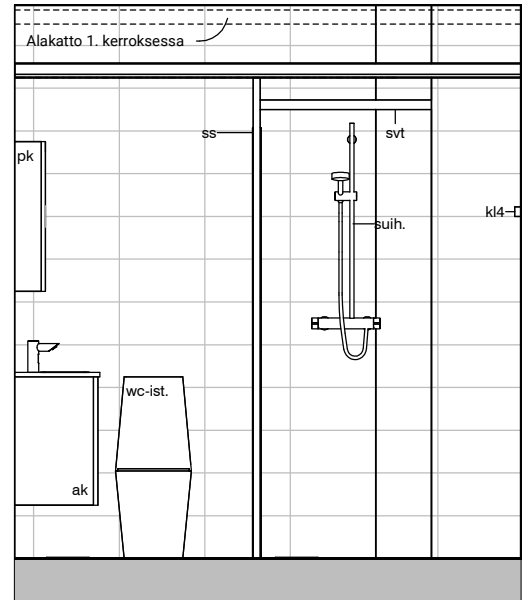
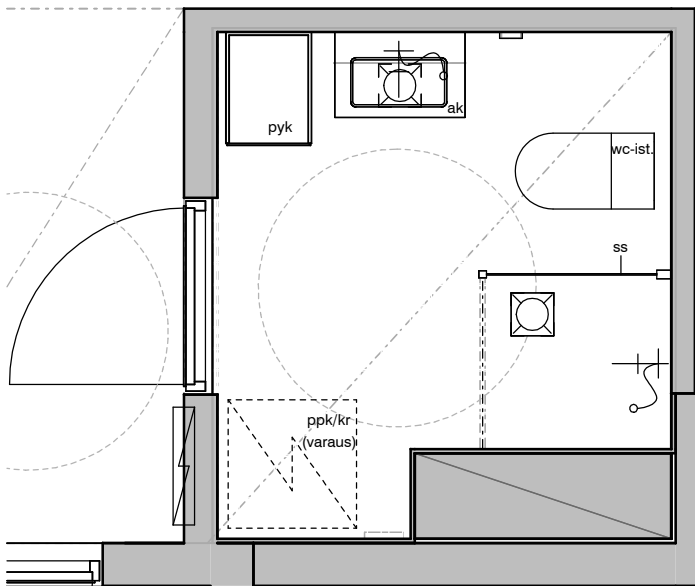

04a

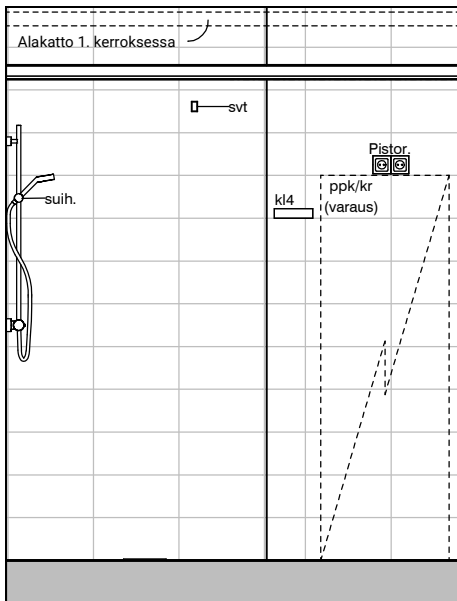

04b

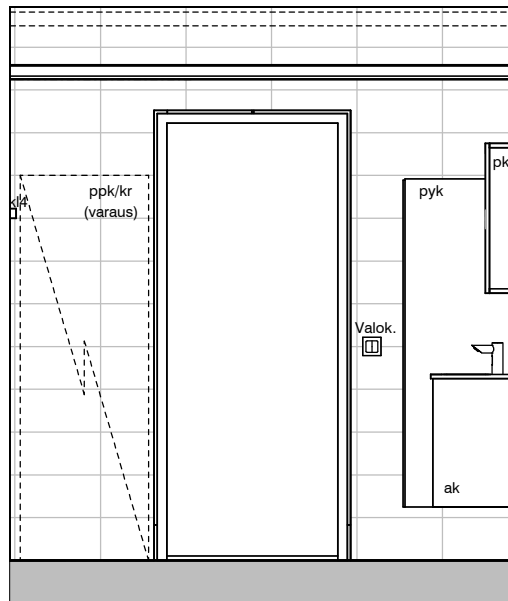

04c

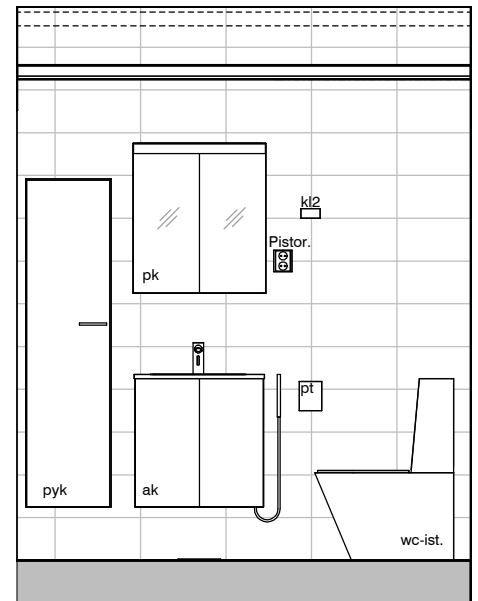

04d

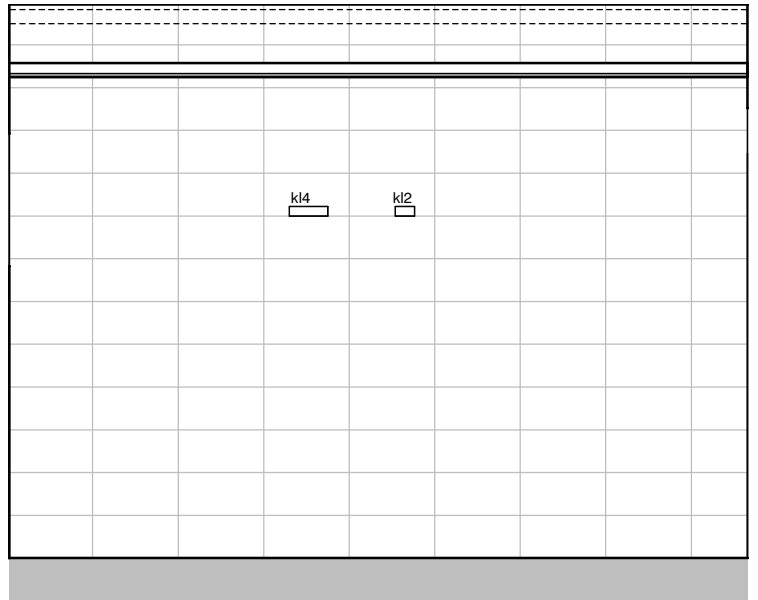
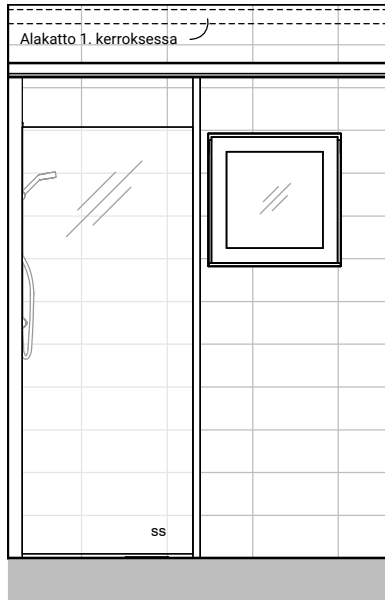
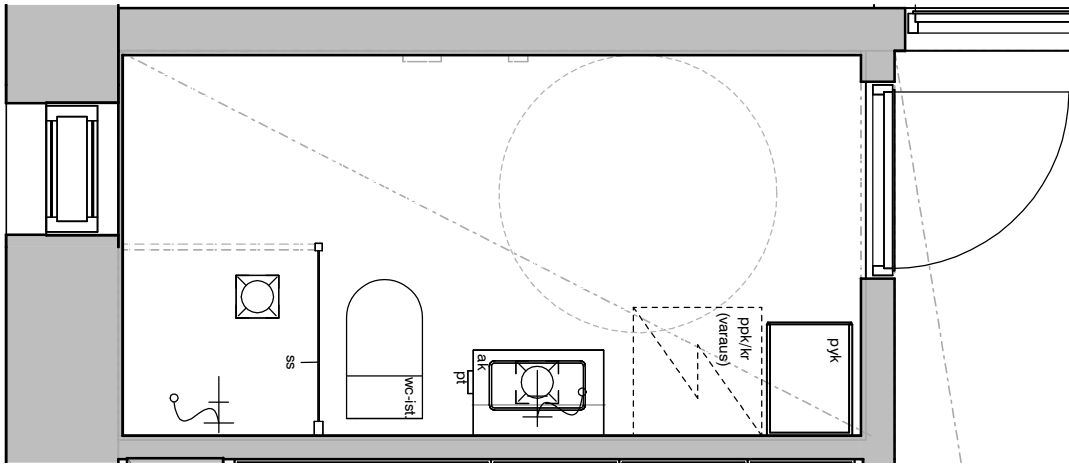



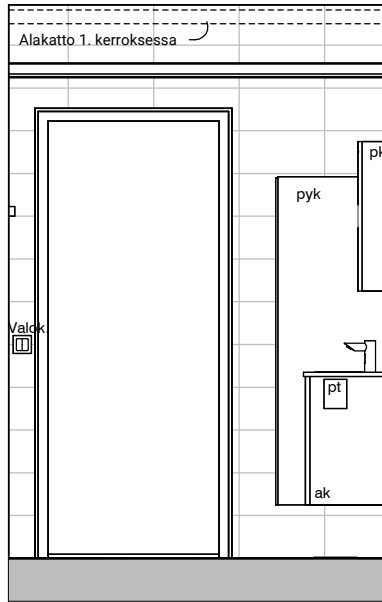

06c

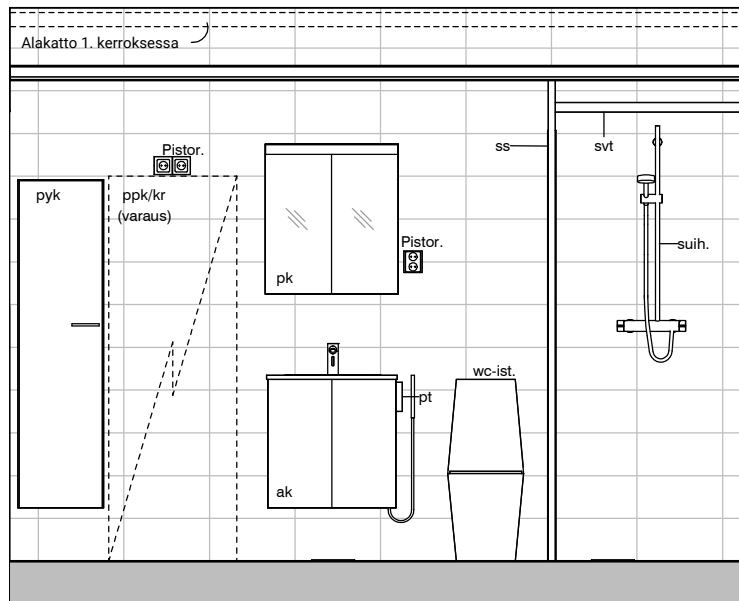

06d

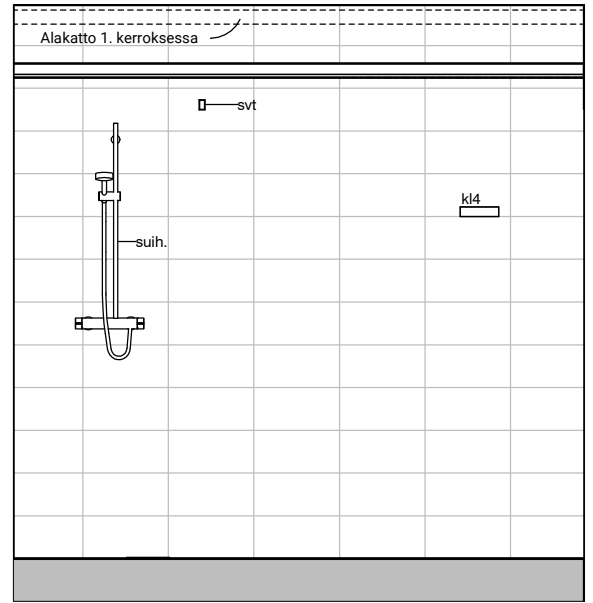
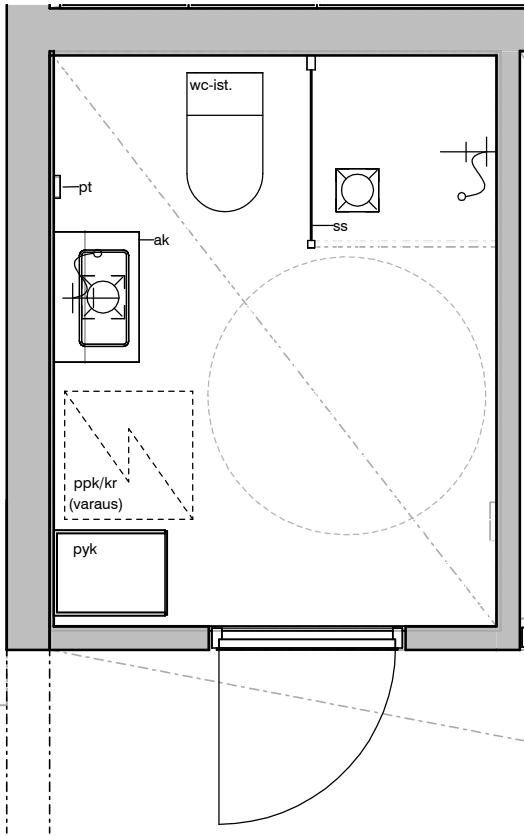

01b

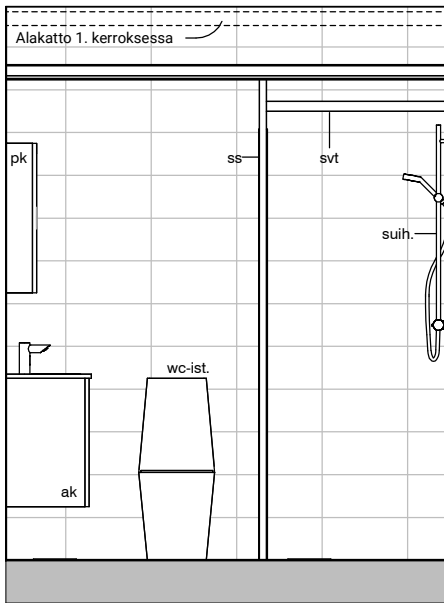

01a

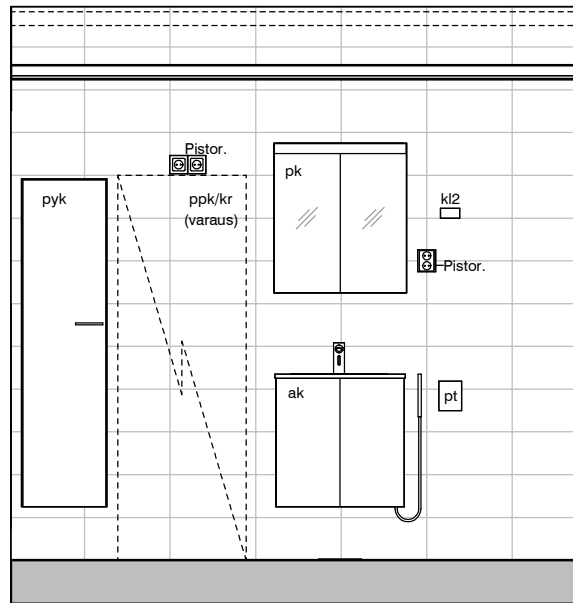

01d

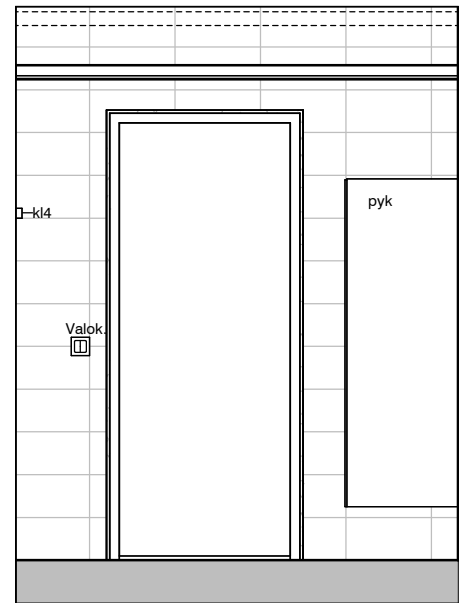

01c

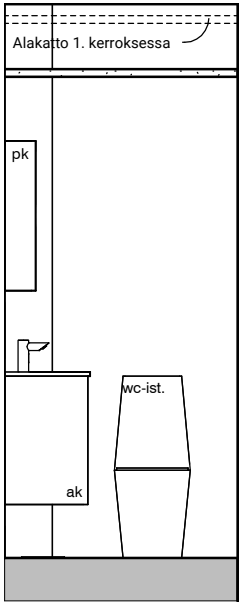
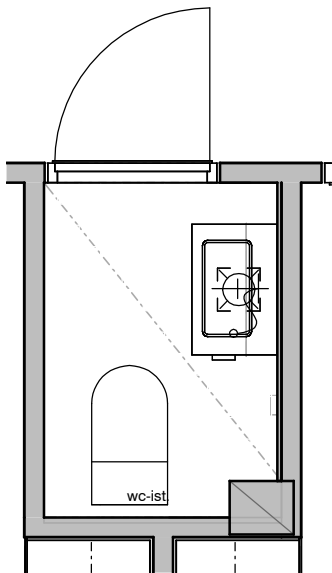

01e

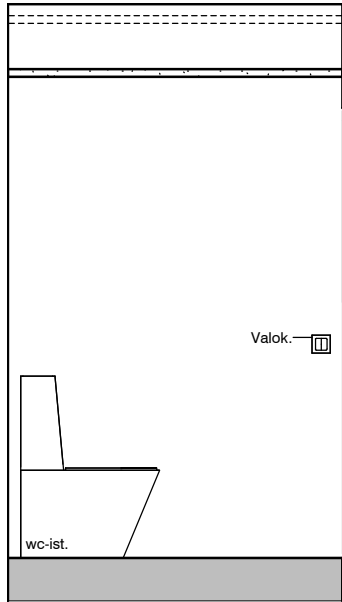

01f

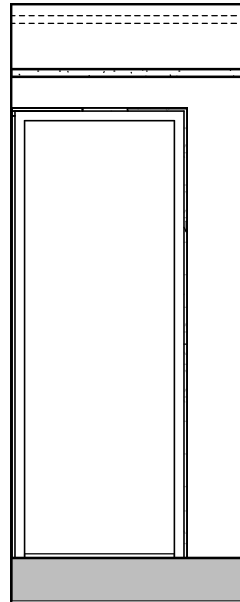

01g

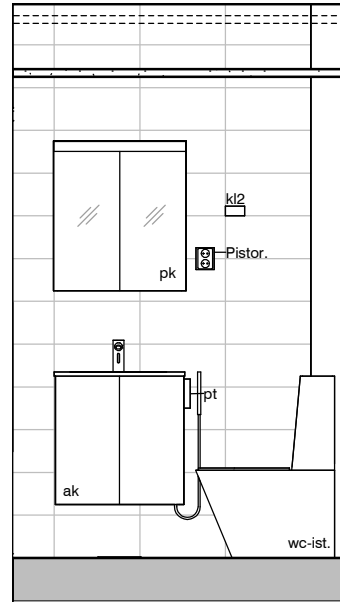

01h

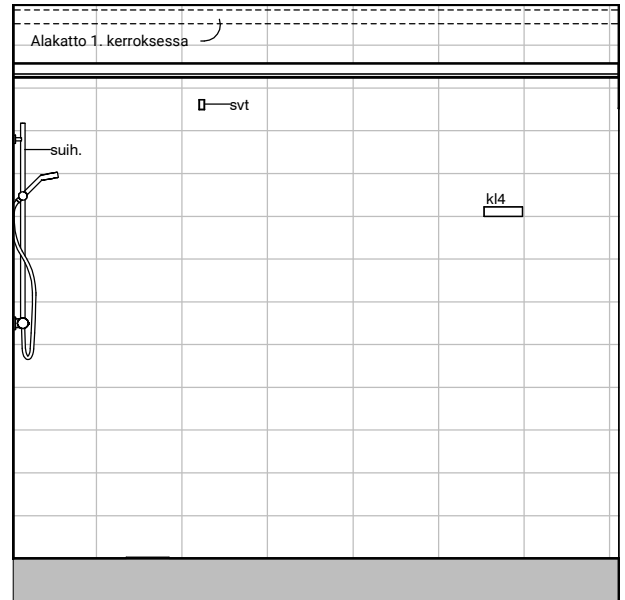
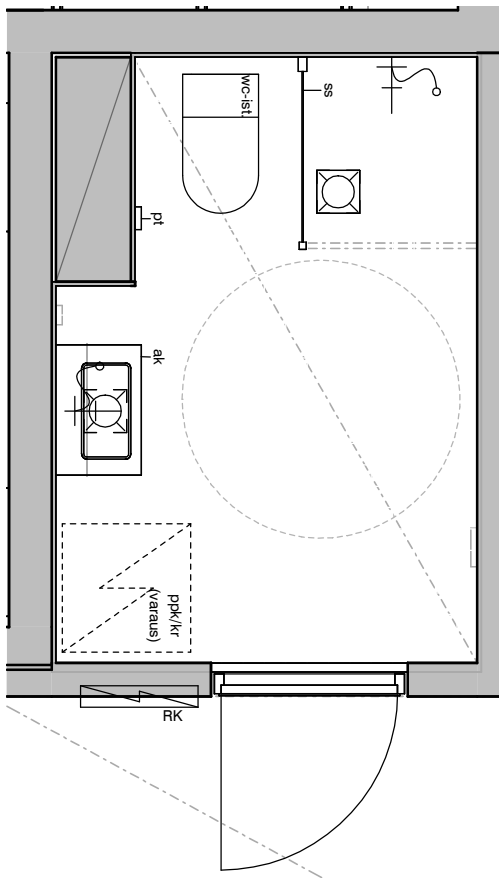

03b

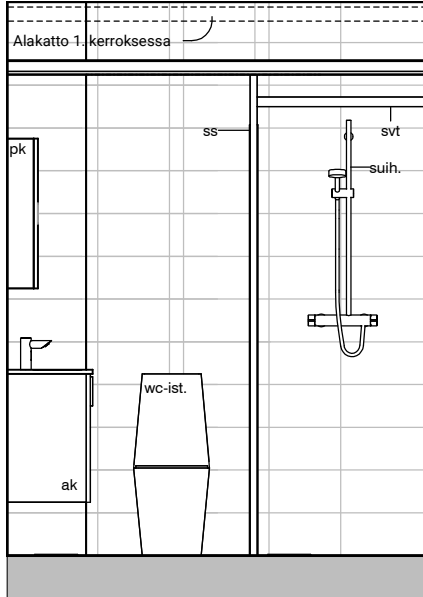

03a

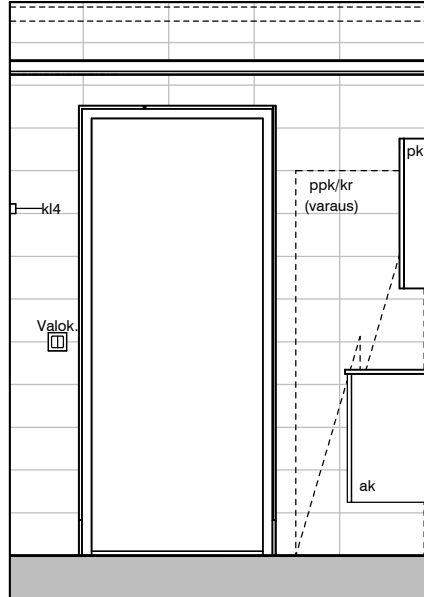

03c

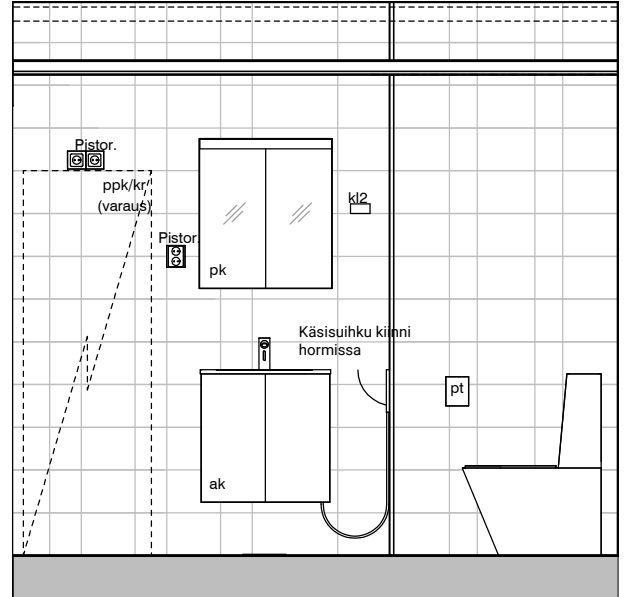

03d



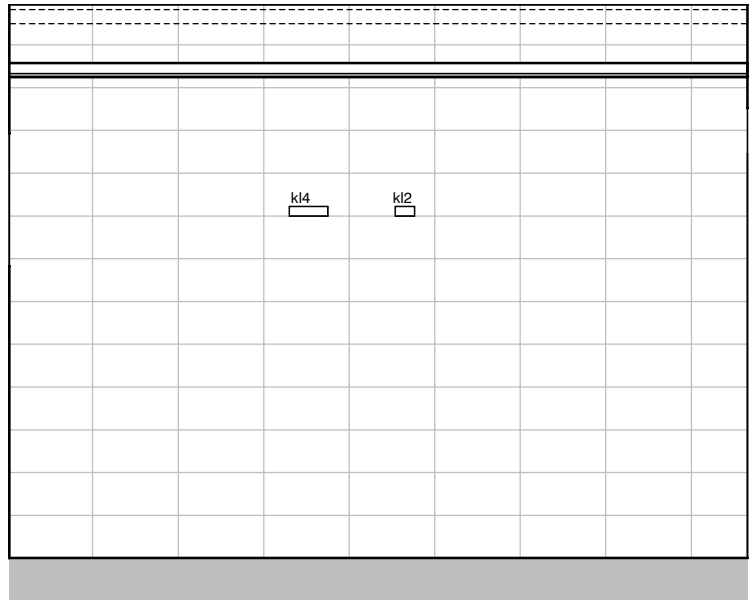
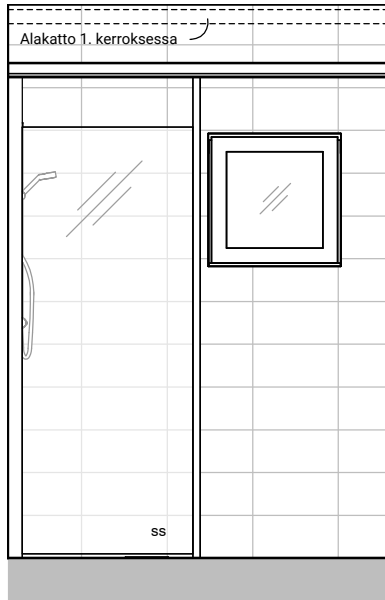
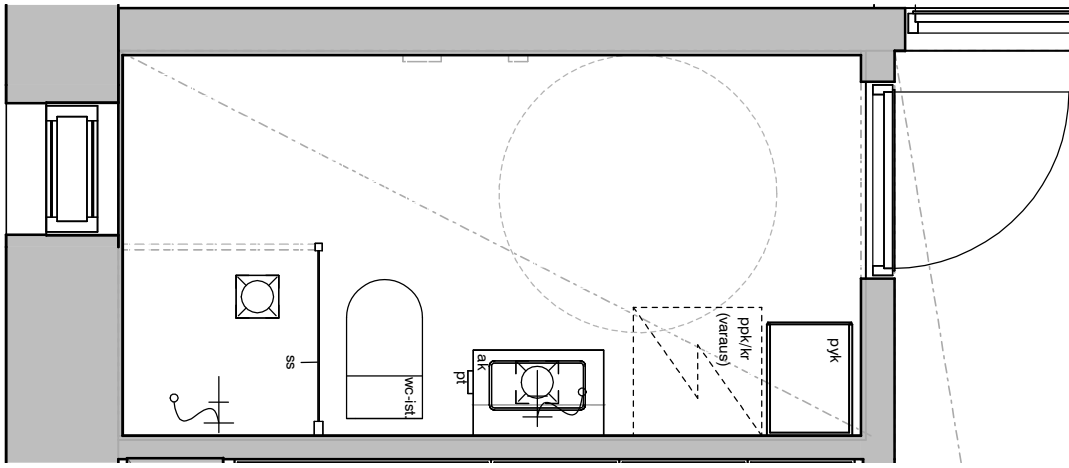

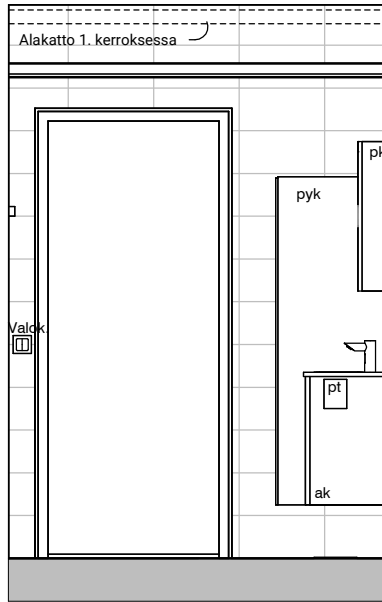

06c

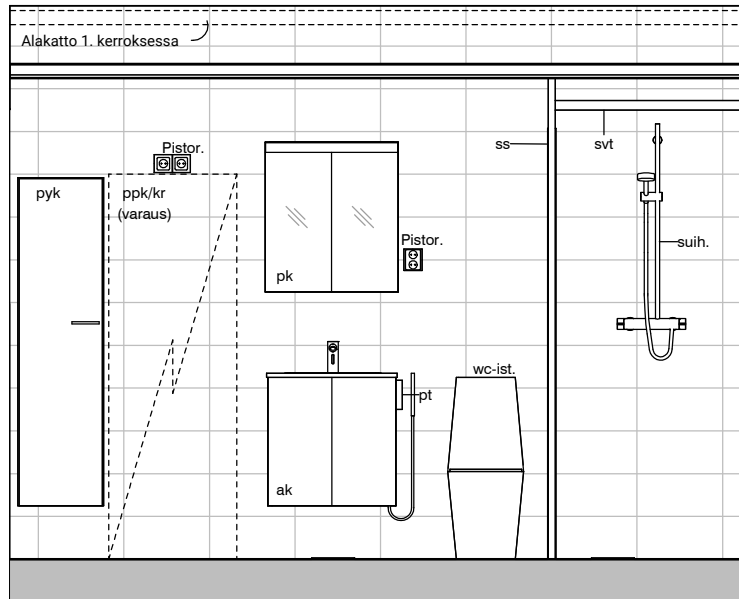

06d

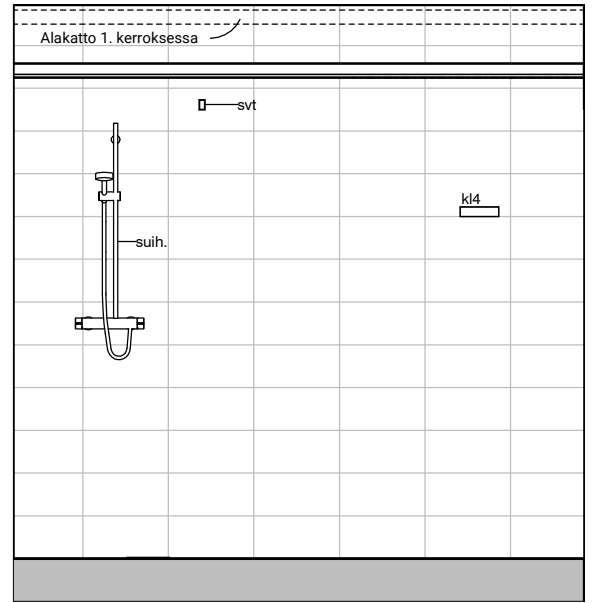
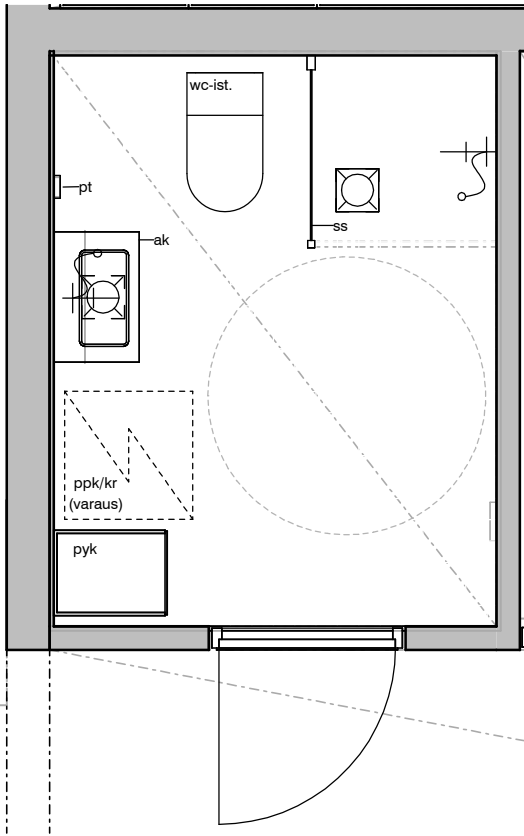

01b

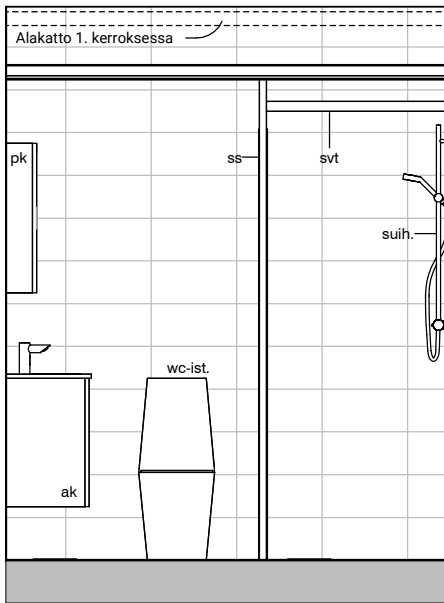

01a

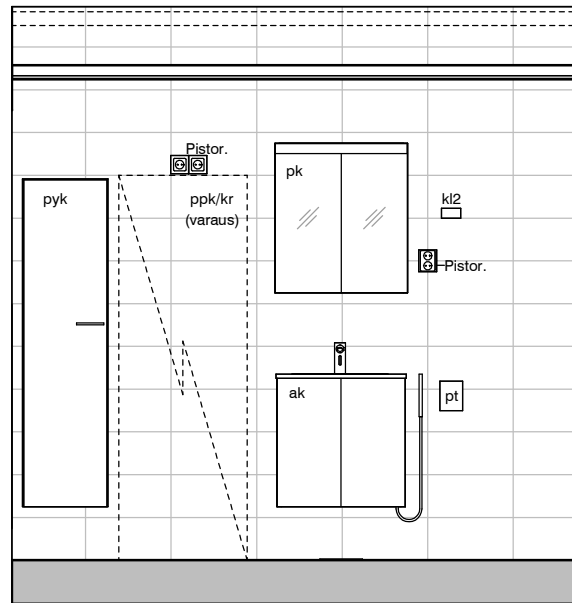

01d

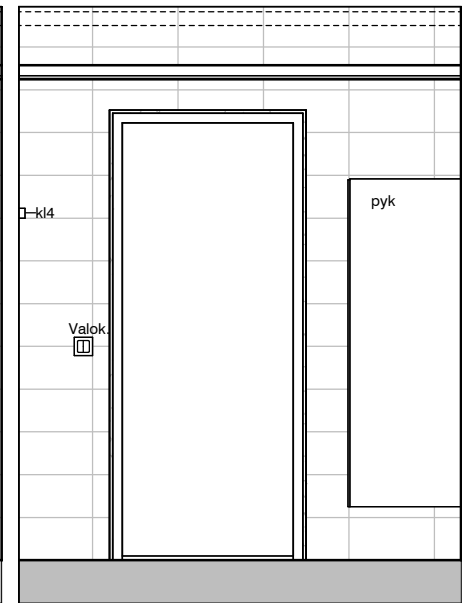

01c



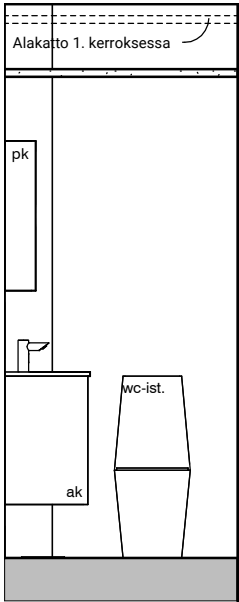
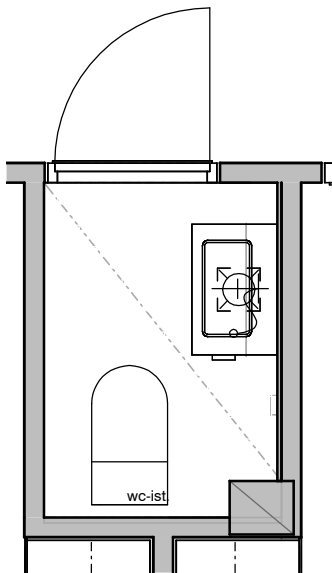

01e

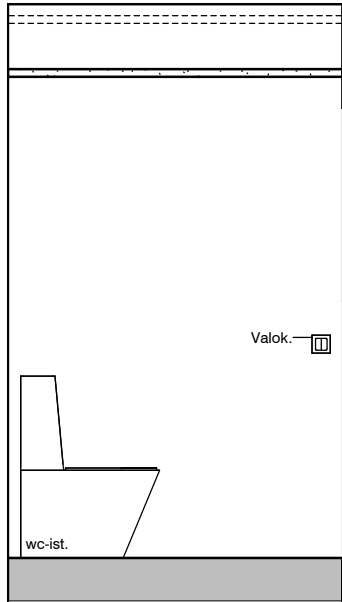

01f

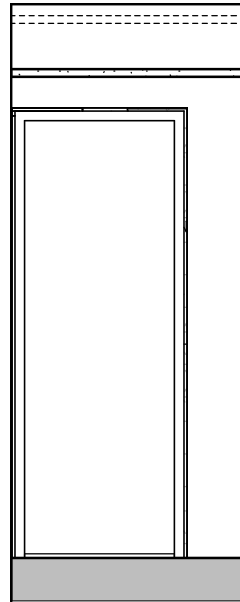

01g

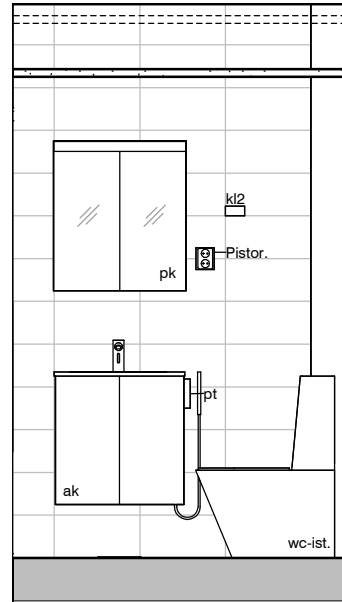

01h

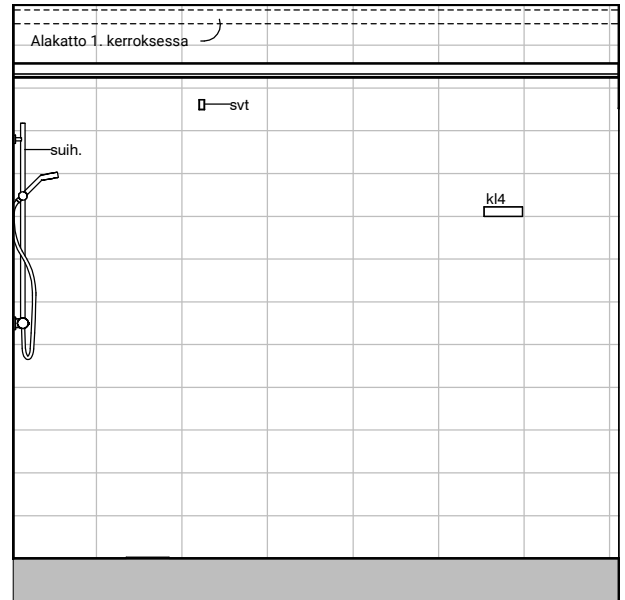
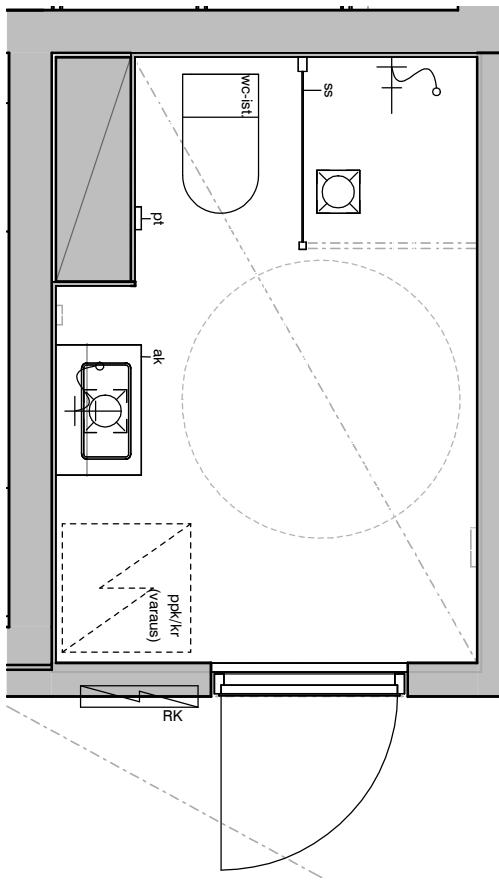

03b

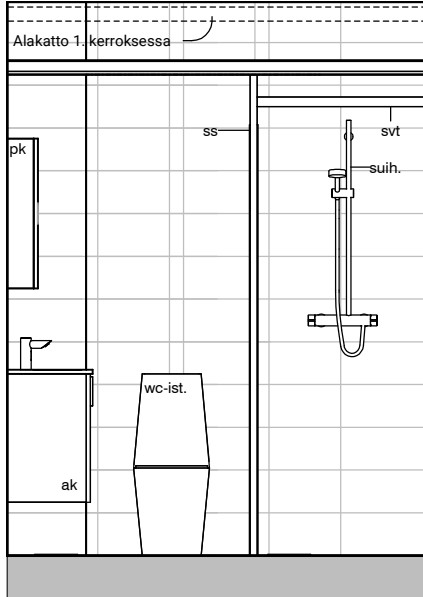

03a

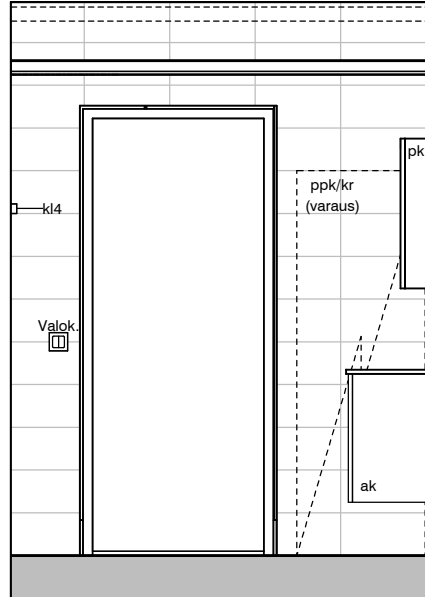

03c

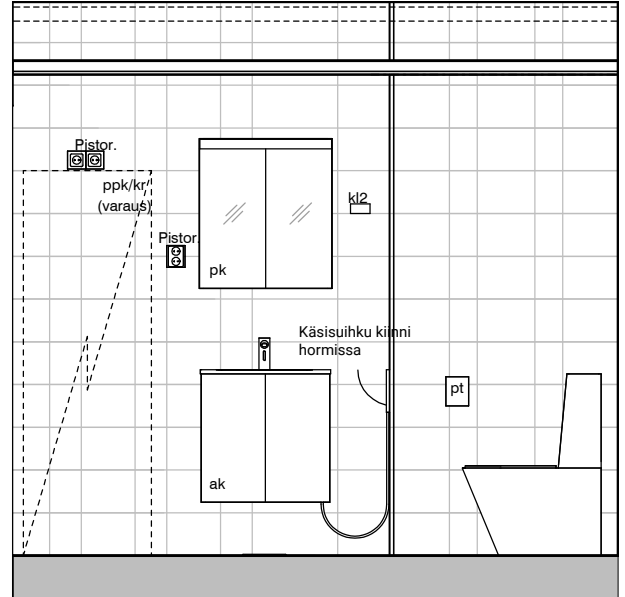

03d

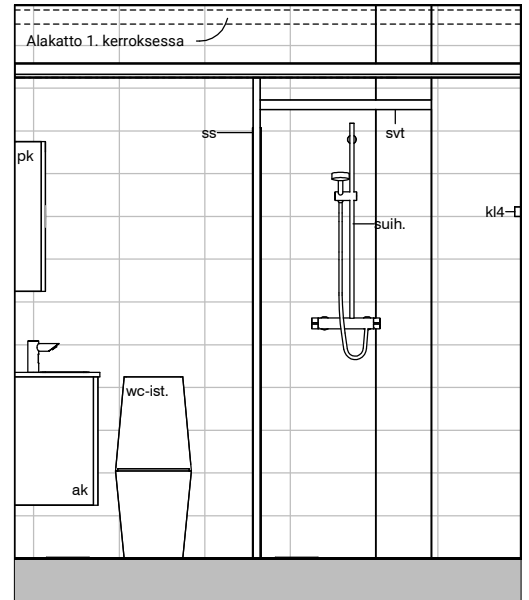
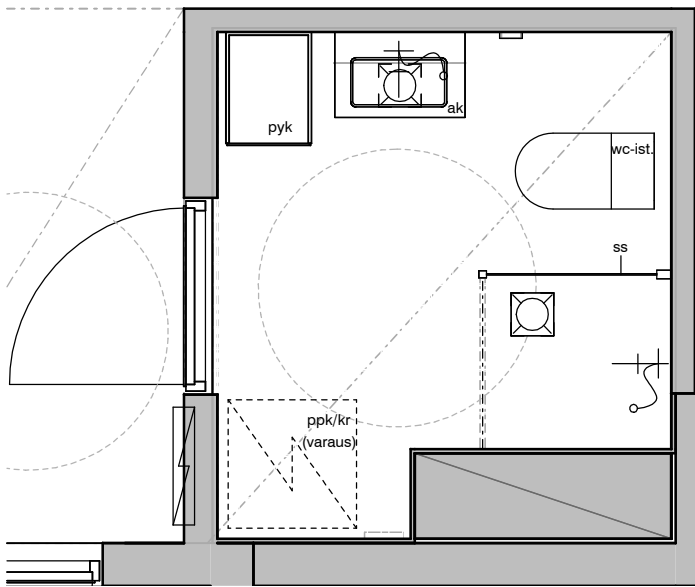

04a

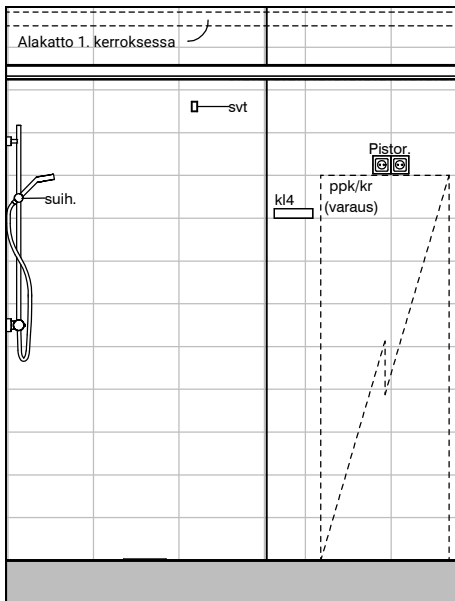

04b

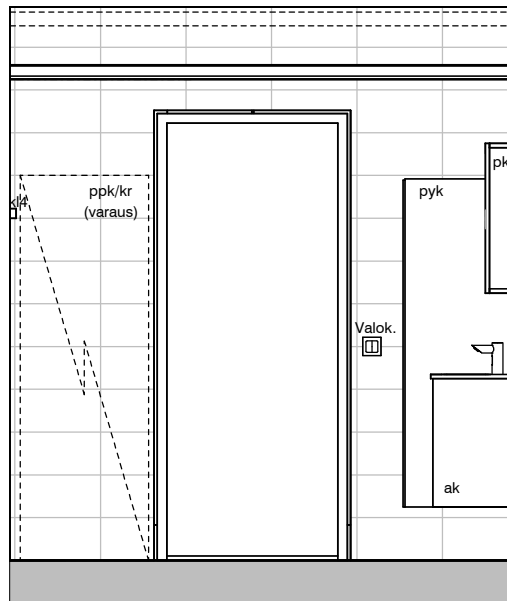

04c

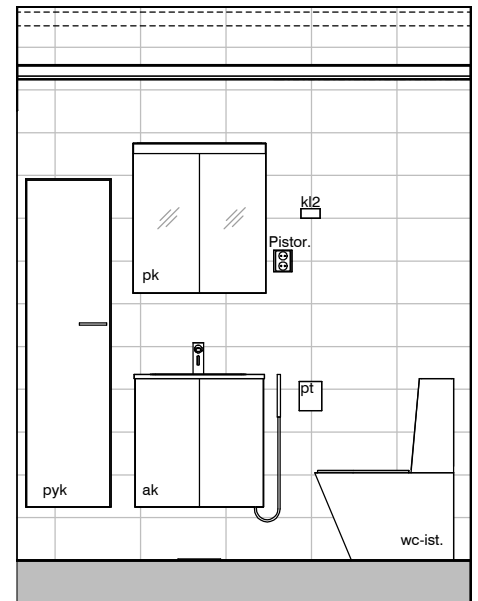

04d

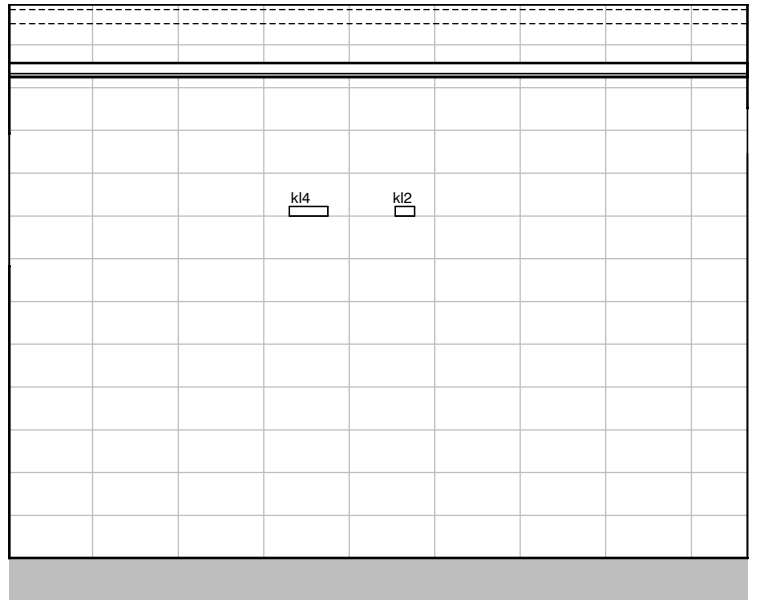
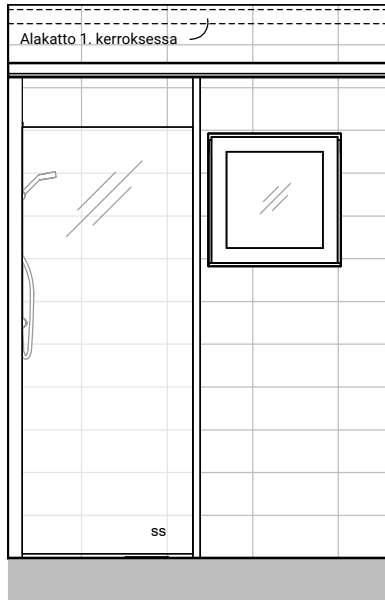
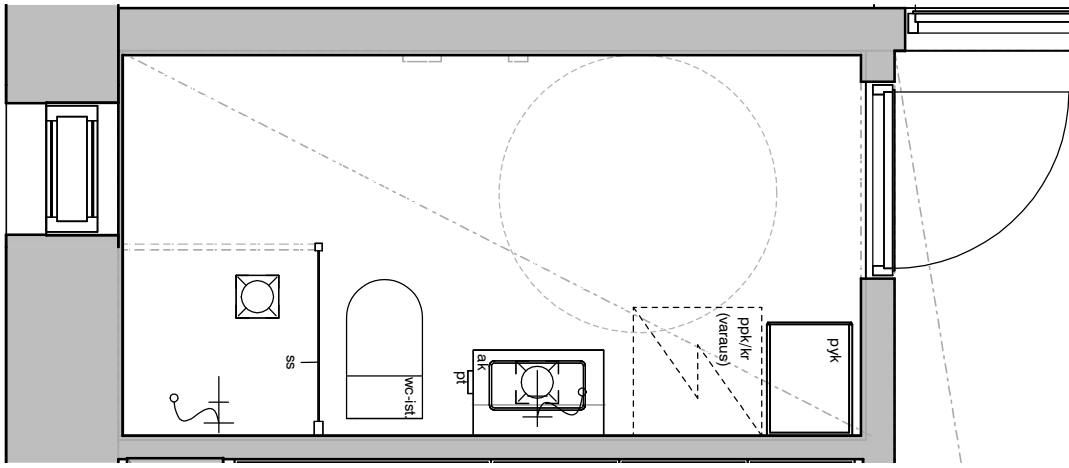

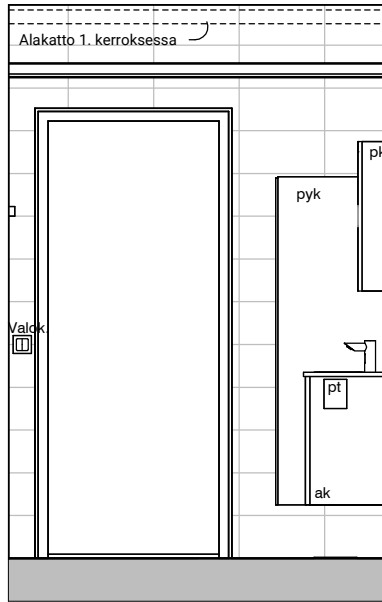

06c

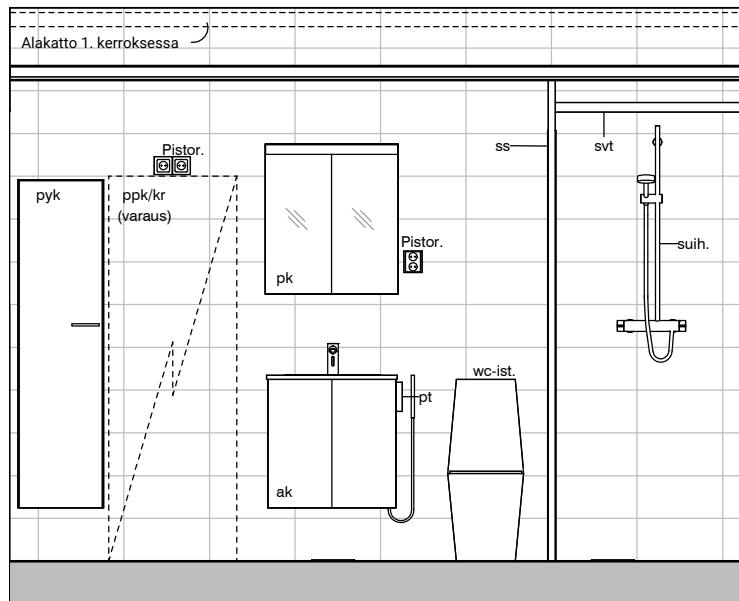

06d

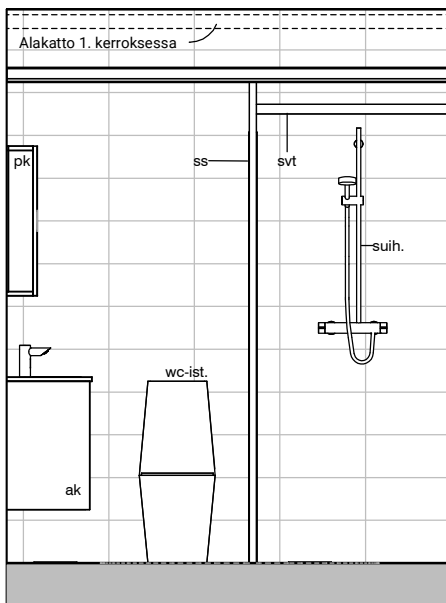
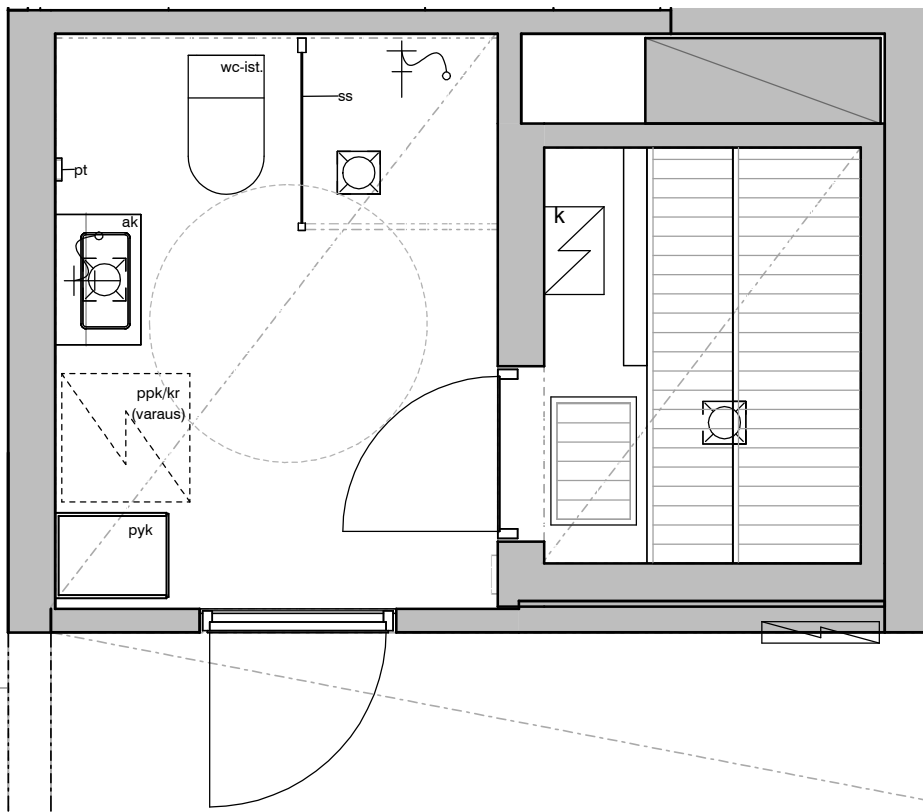

02a

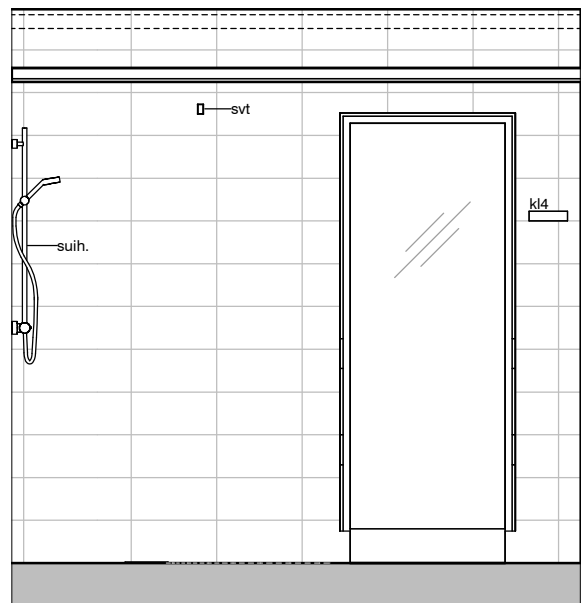

02b

Kylpyhuone ja sauna s.1  
Asunto B31

HASO Maapadontie 9  
Maapadontie 9  
00640  
Helsinki

Kaaviossa olevat tuotteiden kuvat esittävät niiden sijainteja. Kuvat ovat symboleita, tuotteet visuaalisesti esitetyjä ja niihin liittyvät ratkaisut voivat poiketa kaaviossa esitetyistä. Pääosin tuotteet on esitetty "Asunnon materiaalivalinnat"-aineistossa. Kaavion mitat ovat moduulimittoja, todelliset mitat saattavat poiketa valmistajasta riippuen. Esitetyt alaslaskujen mitat ovat tavoitteellisia ja saattavat poiketa kuvassa esitetyistä mitoista talotekniikasta johtuvista syistä.

12.4.2024

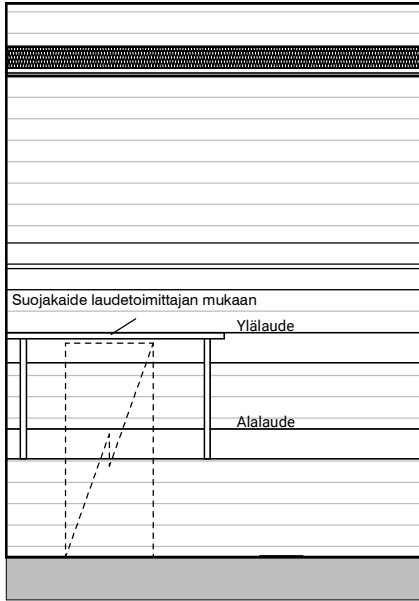

02e

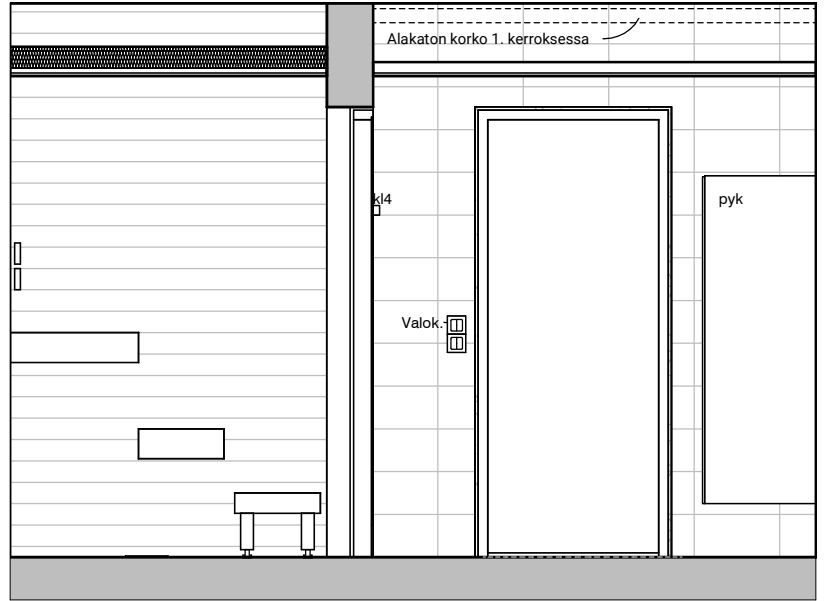

02c

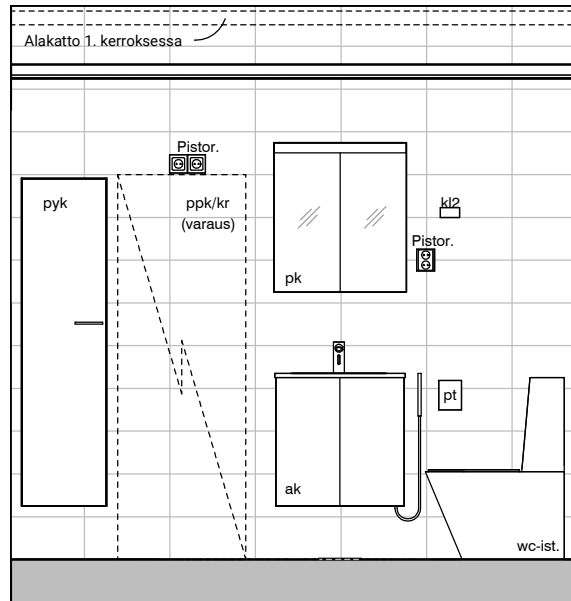

02d

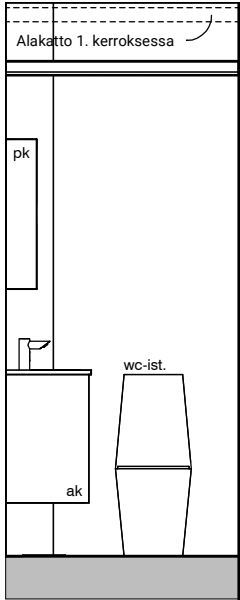
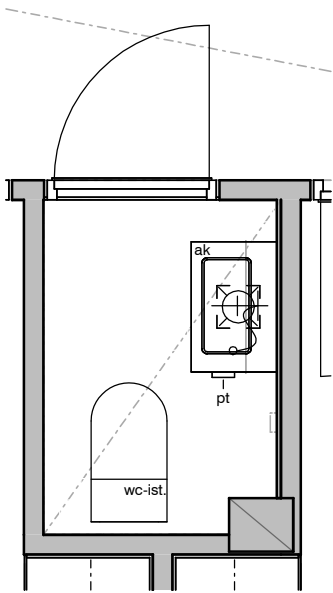

02f

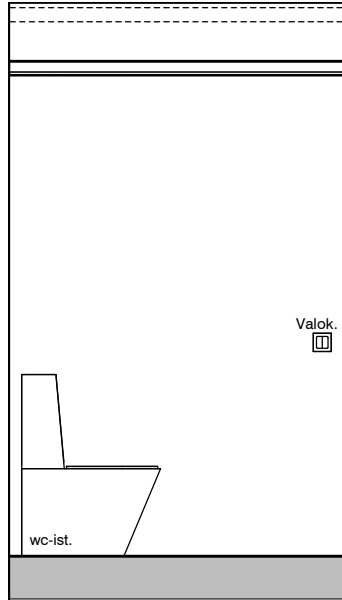

02g

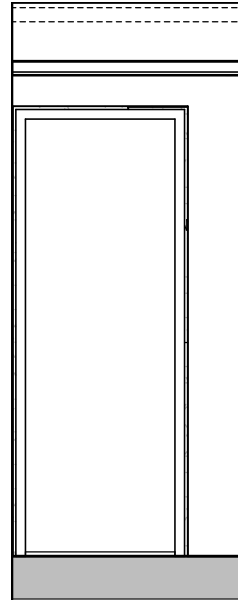

02h

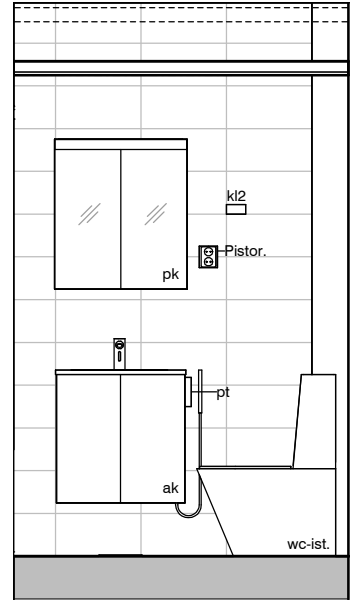

02i



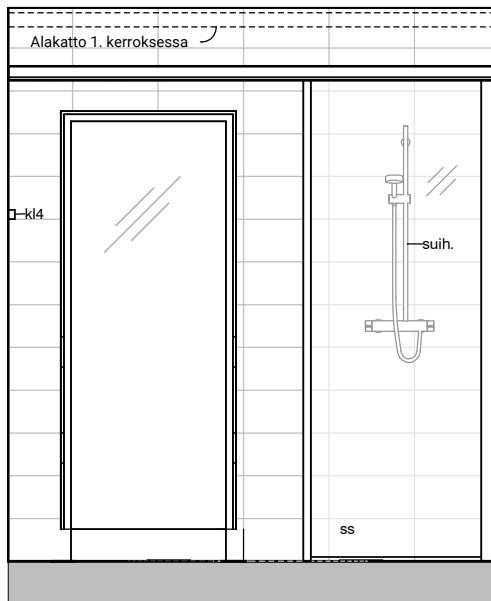
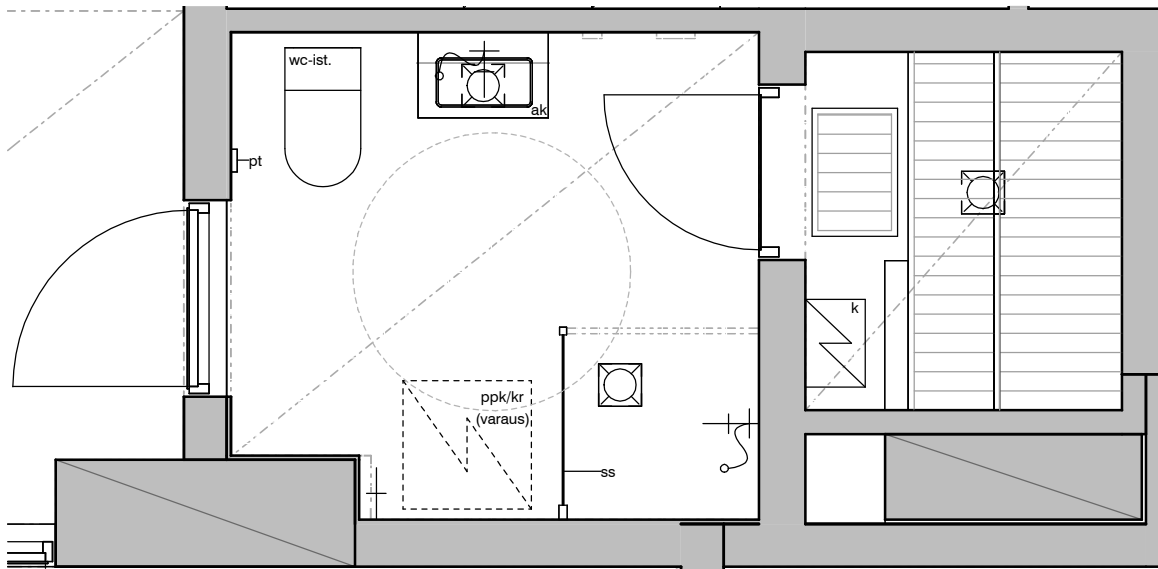

05a

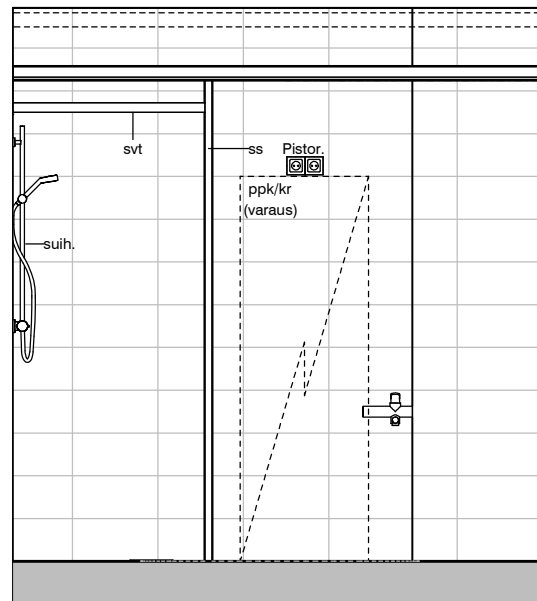

05b

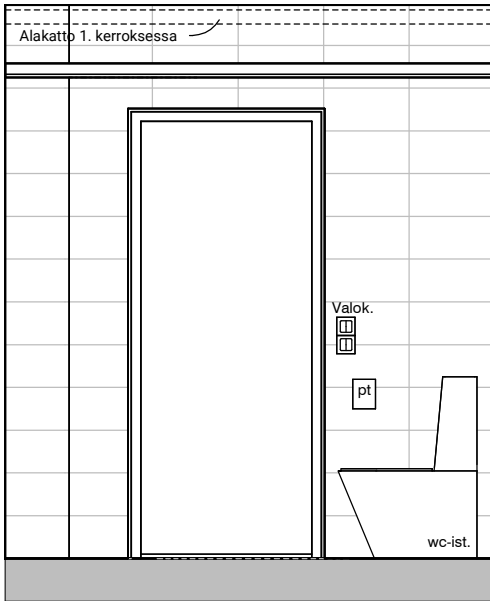

05c

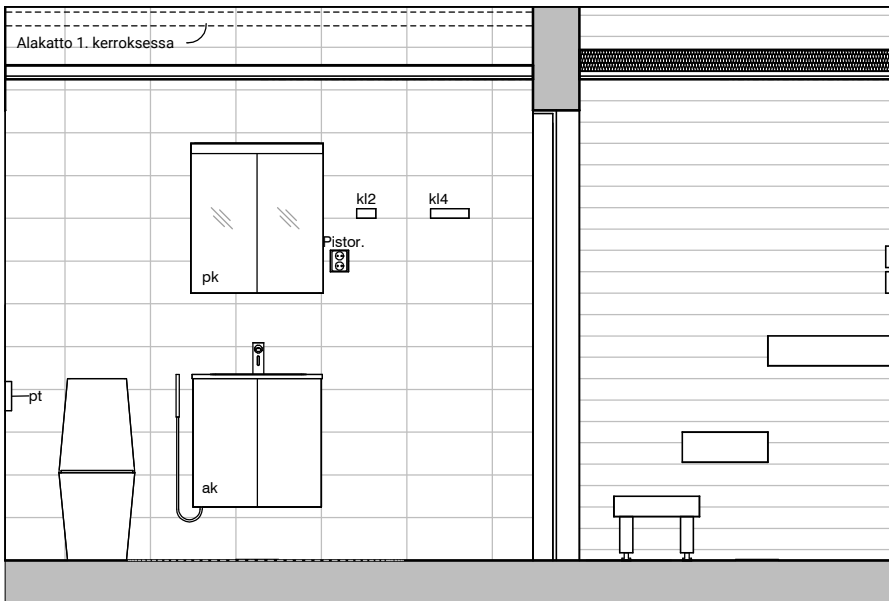

05d

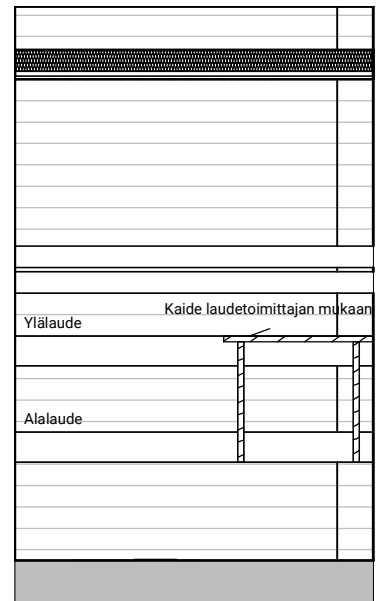

05e

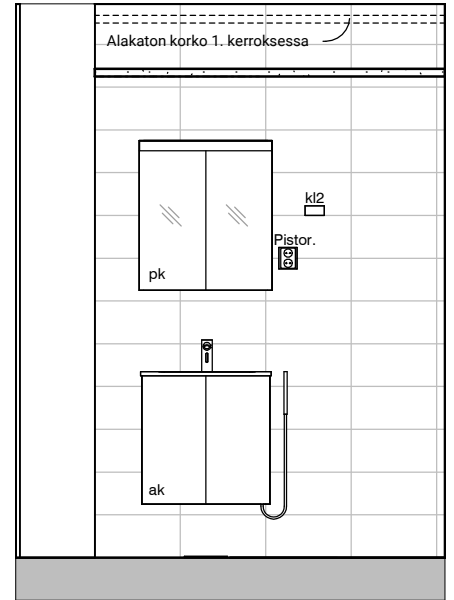
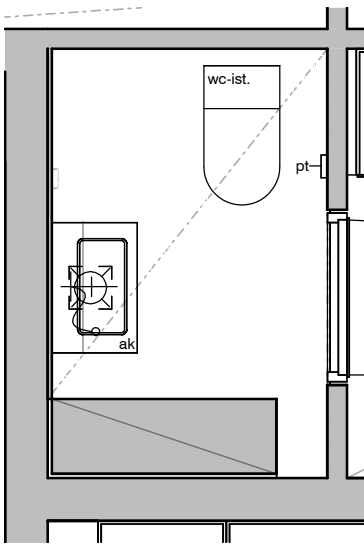

05f

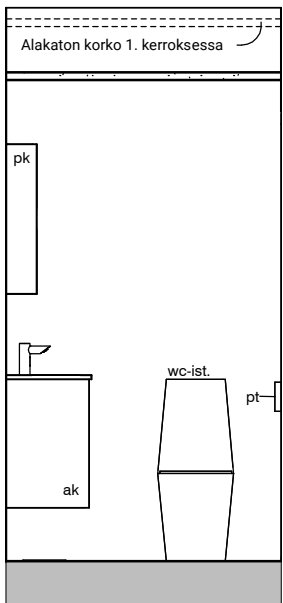

05g

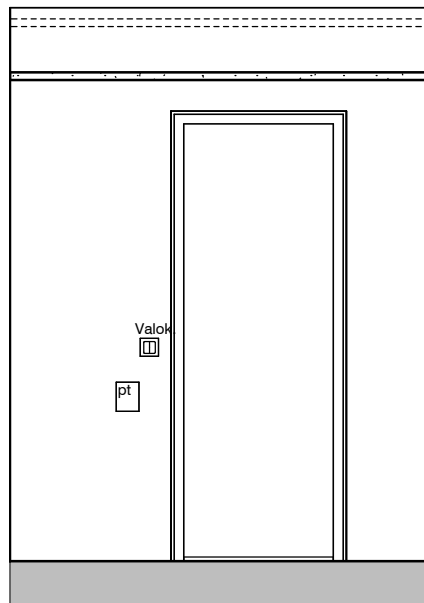

05h

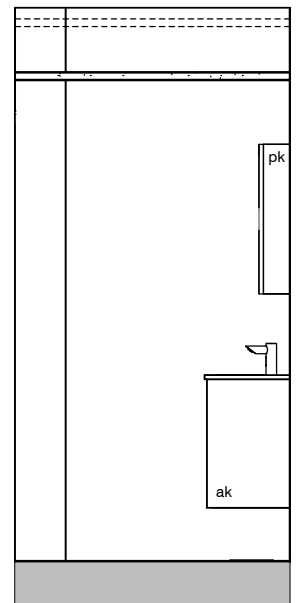

05i

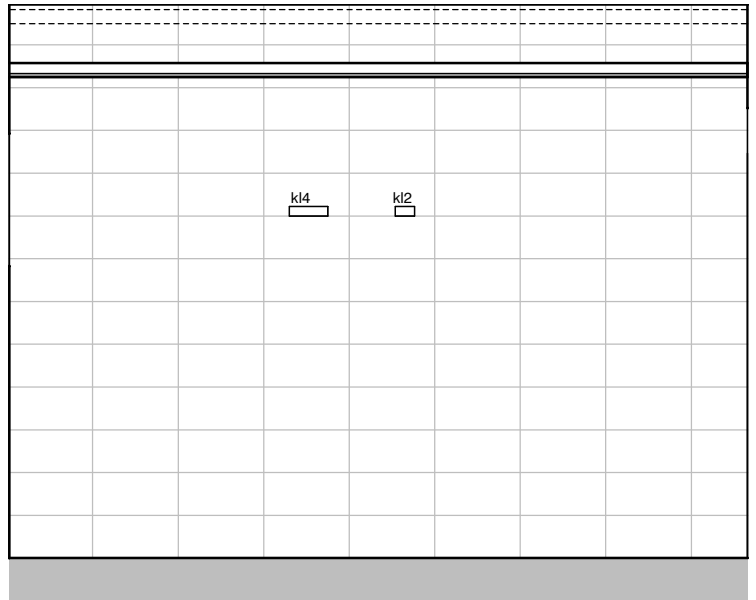
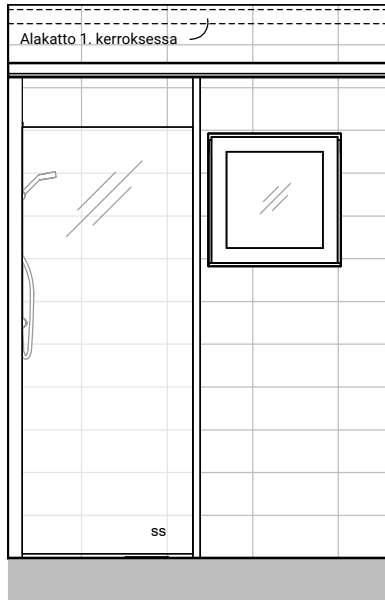
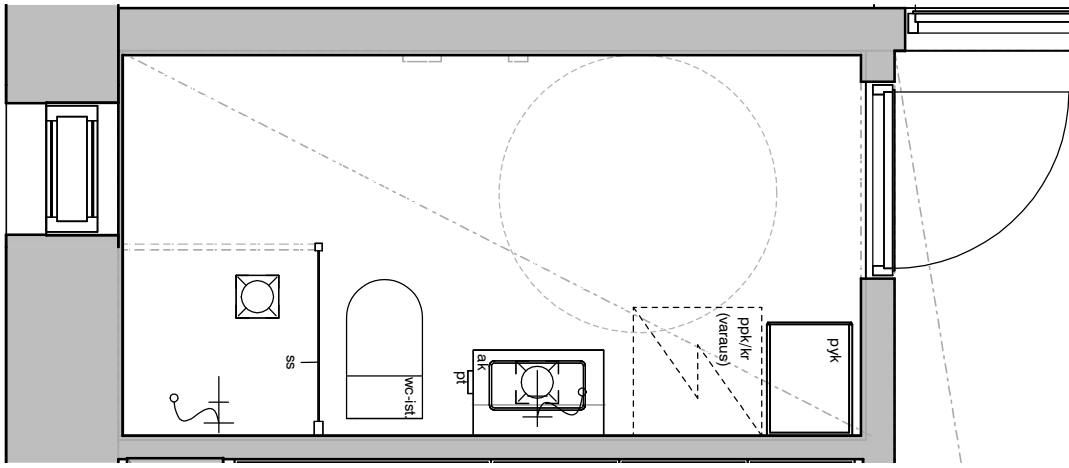

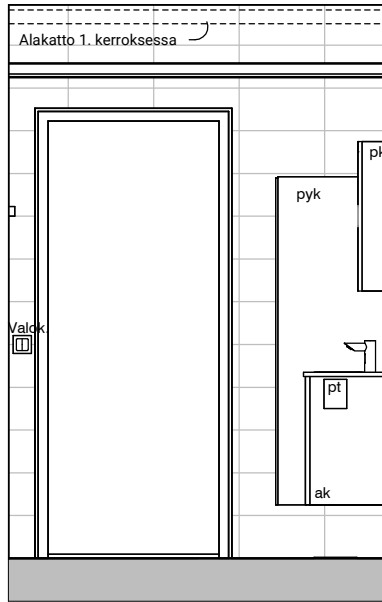

06c

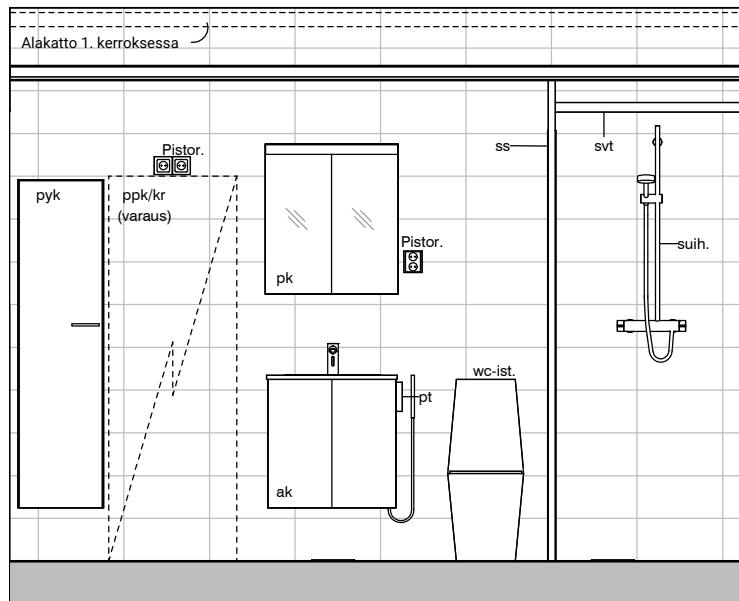

06d