

02a

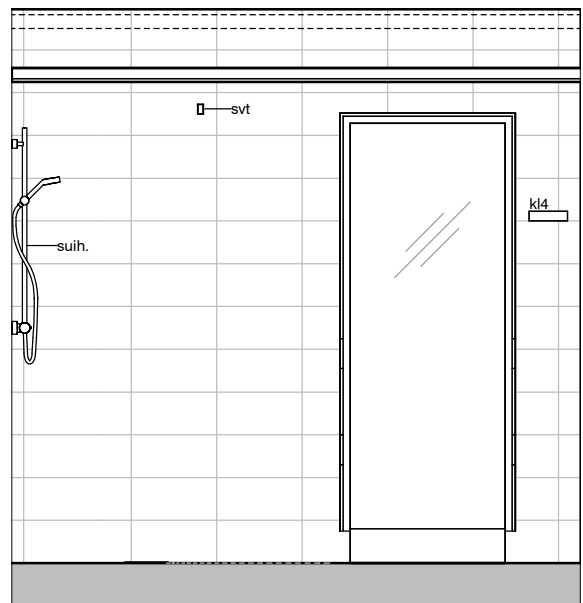

02b

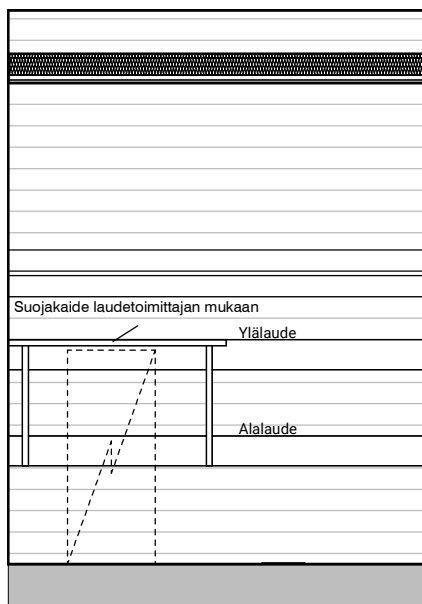

02e

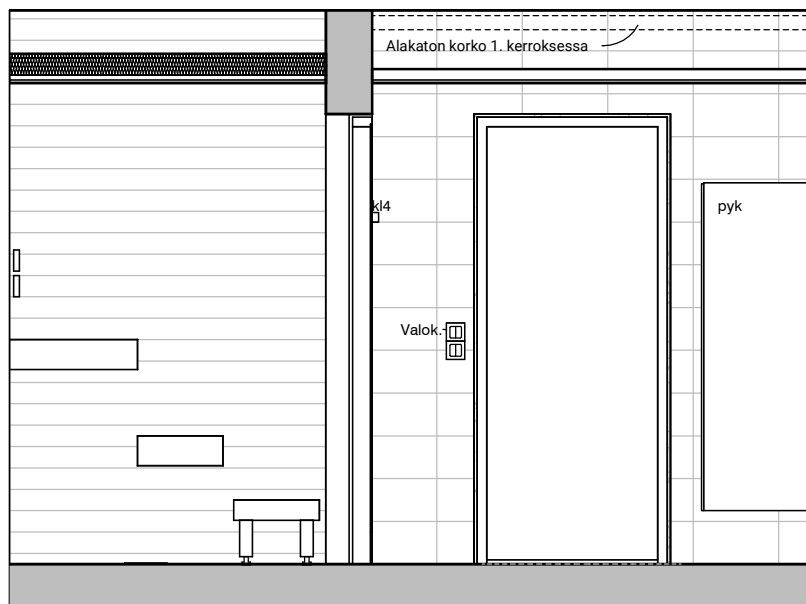

02c

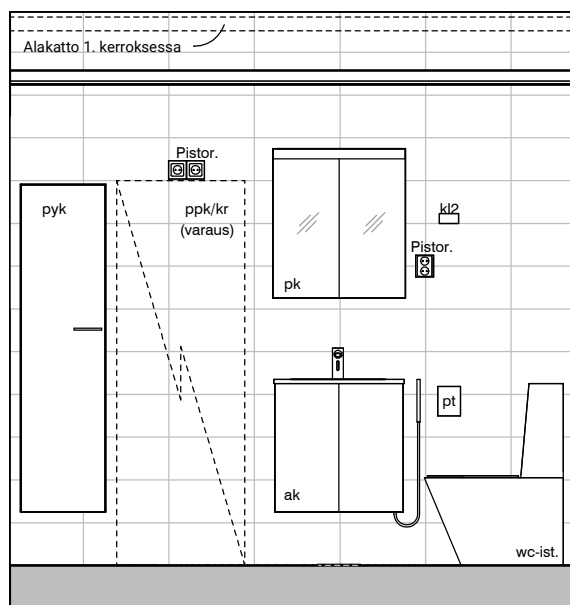

02d

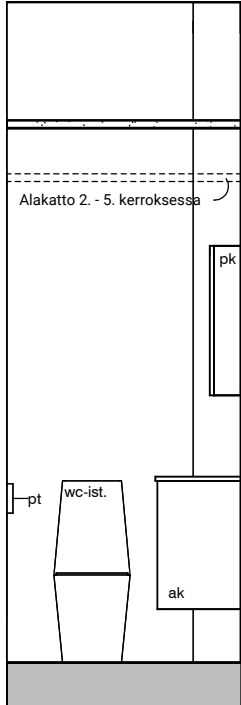
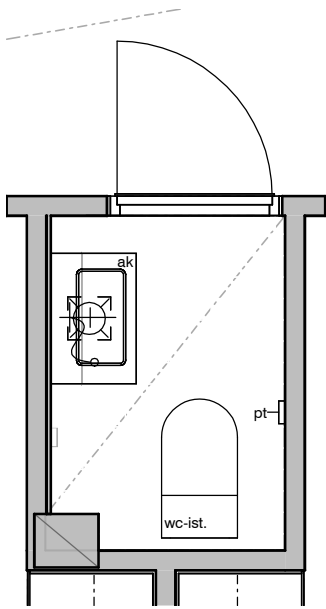

02j

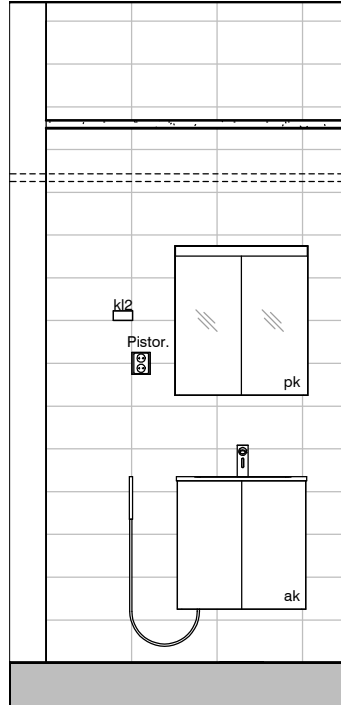

02k

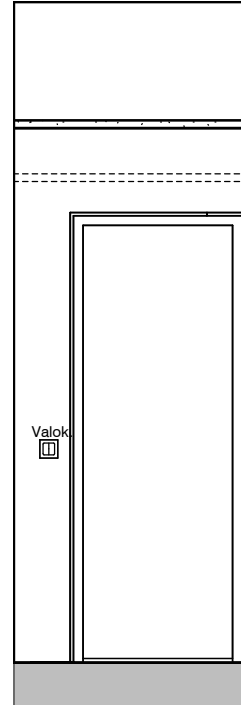

02l

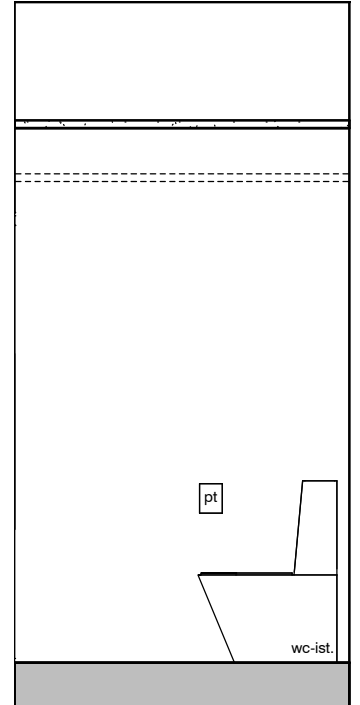

02m

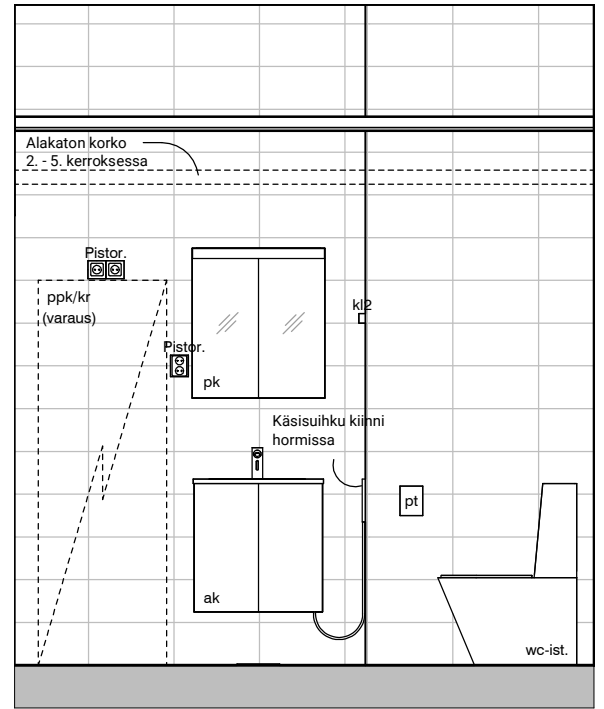
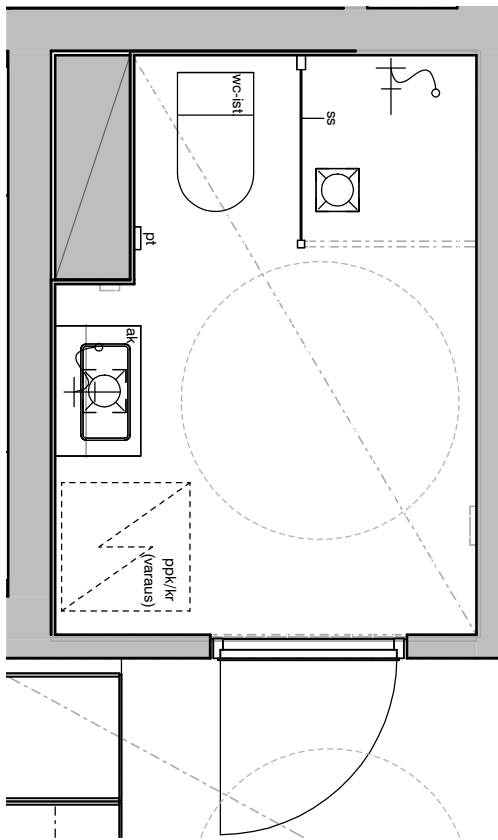

07d

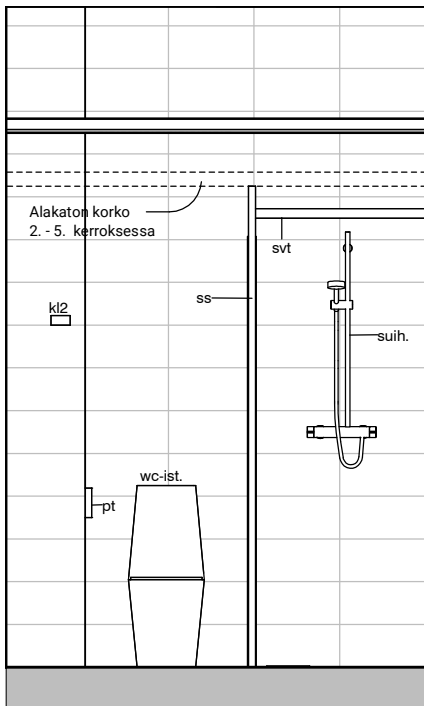

07a

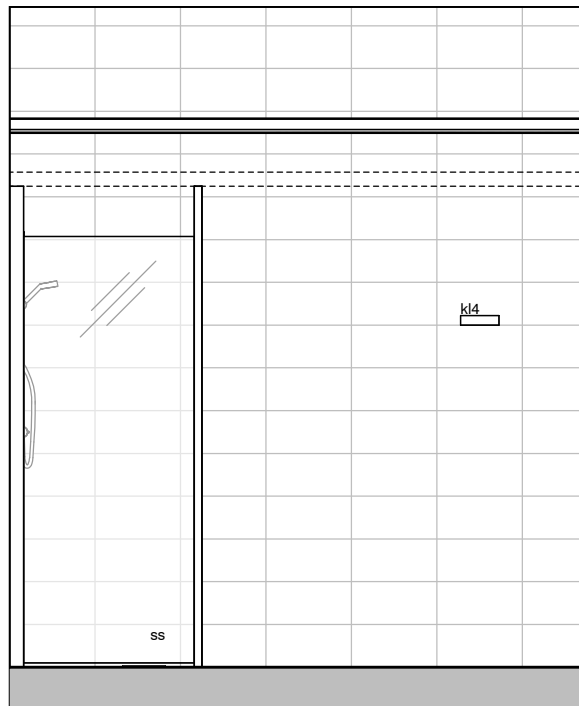

07b

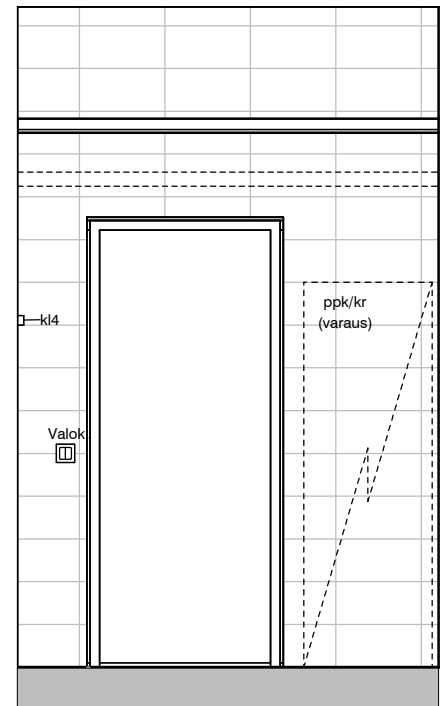

07c

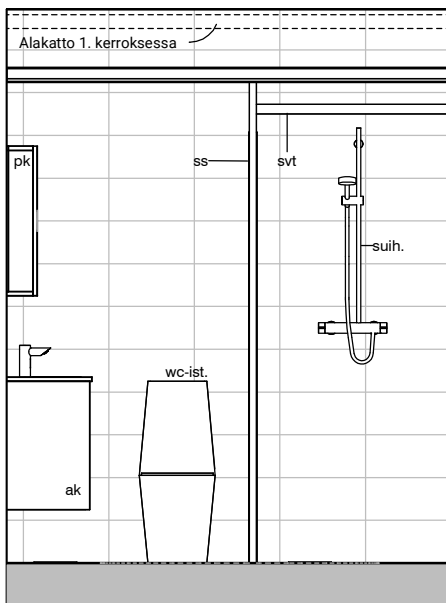
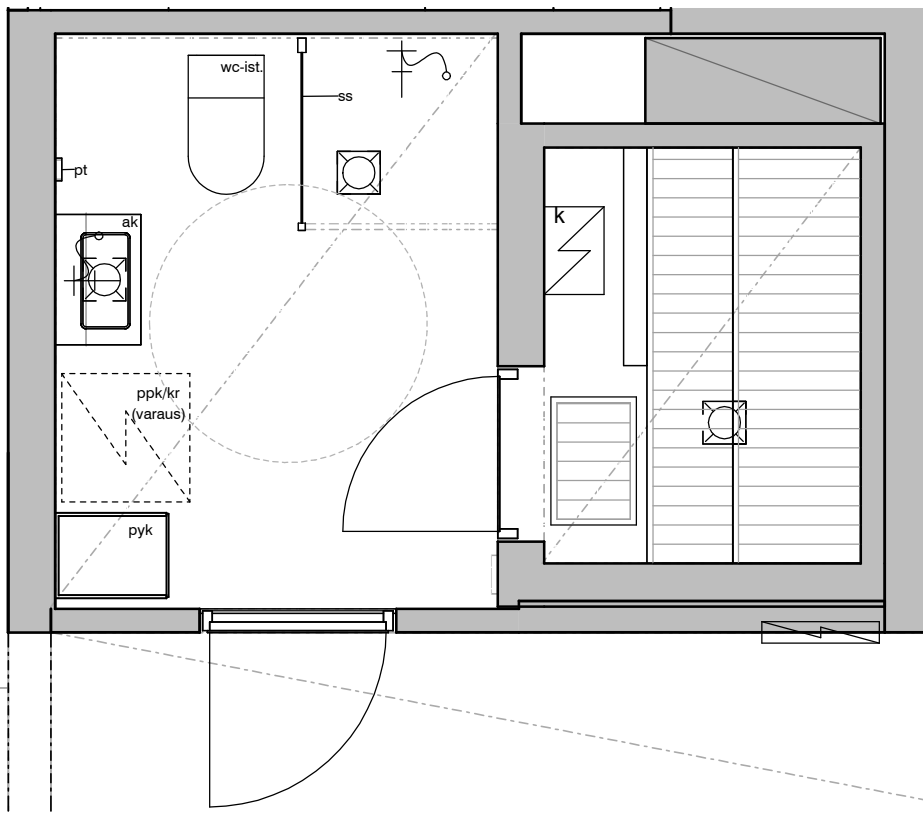

02a

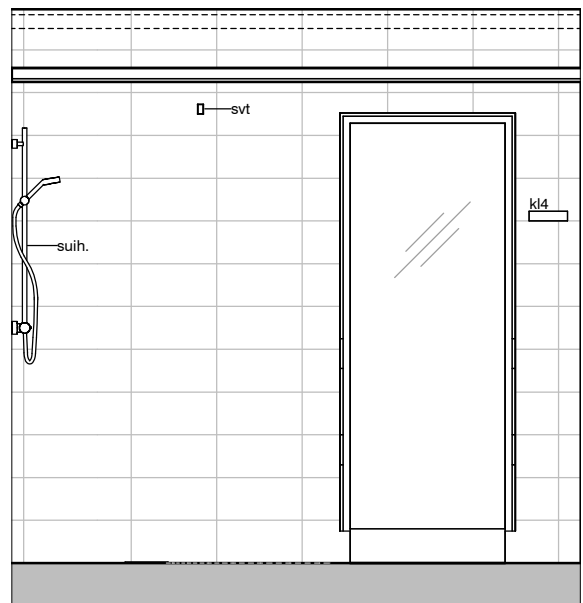

02b

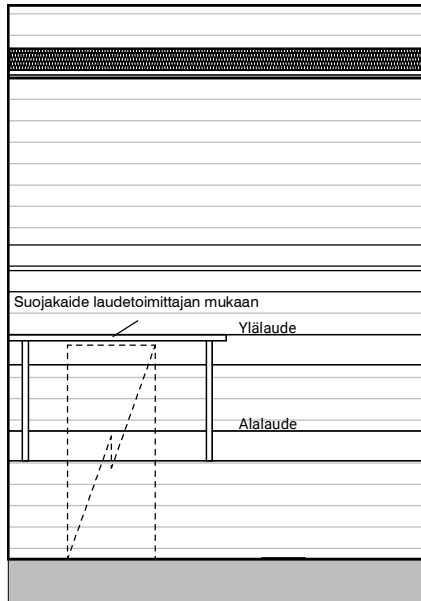

02e

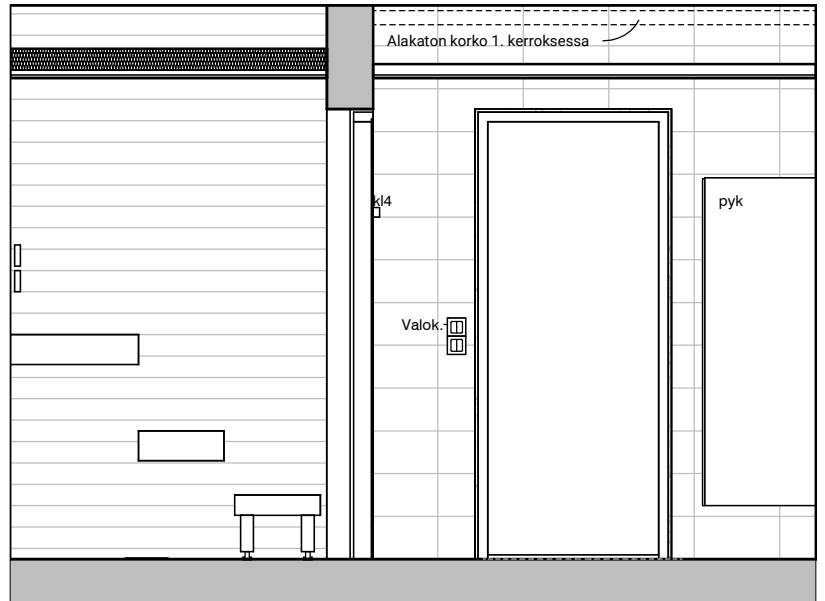

02c

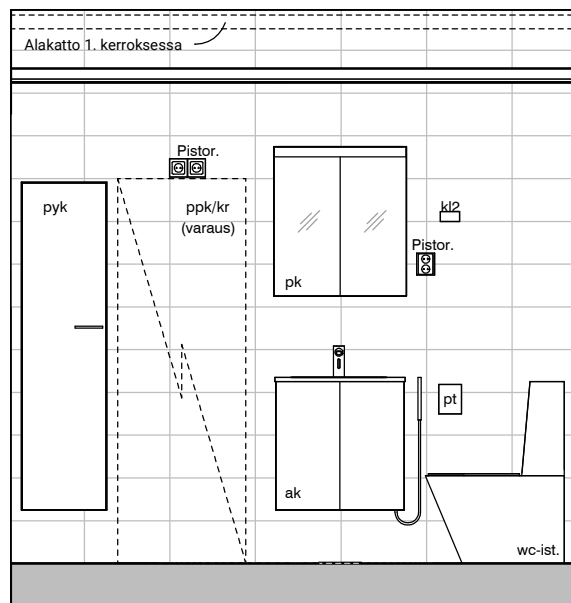

02d

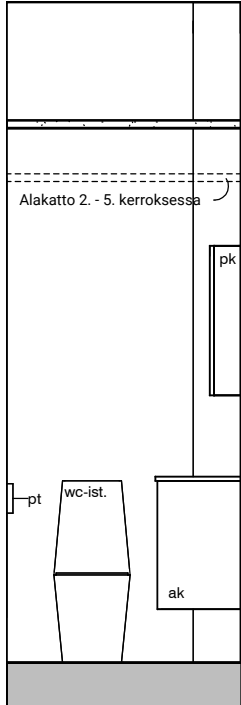
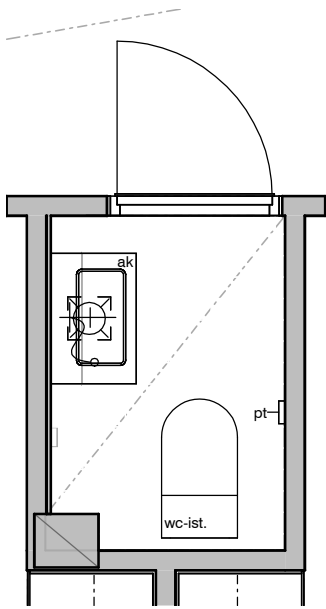

02j

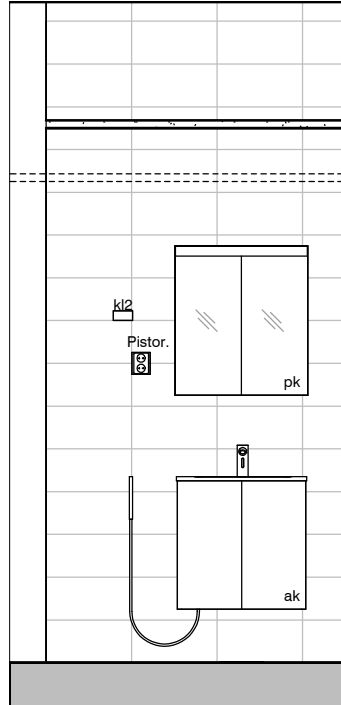

02k

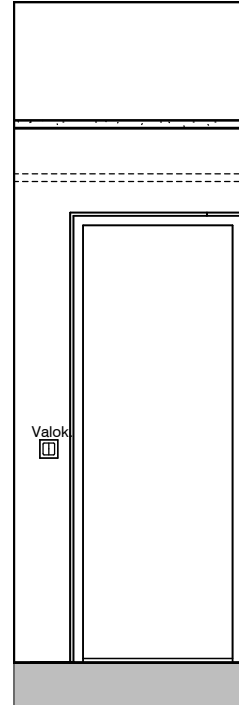

02l

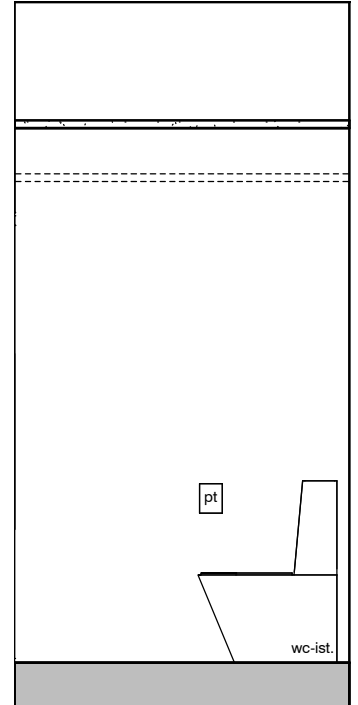

02m

Vessa  
Asunto C36

HASO Maapadontie 9  
Maapadontie 9  
00640  
Helsinki

Kaaviossa olevat tuotteiden kuvat esittävät niiden sijainteja.  
Kuvat ovat symboleita, tuotteet visuaalisesti esitettynä ja  
niihin liittyvät ratkaisut voivat poiketa kaaviossa esitetyistä.  
Pääosin tuotteet on esitetty "Asunnon materiaalivalinnat"-  
aineistossa. Kaavion mitat ovat moduulimittoja, todelliset  
mitat saattavat poiketa valmistajasta riippuen. Esitetyt  
alaslaskujen mitat ovat tavoitteellisia ja saattavat poiketa  
kuvassa esitetyistä mitoista taloteknisistä johtuvista syistä.

12.4.2024

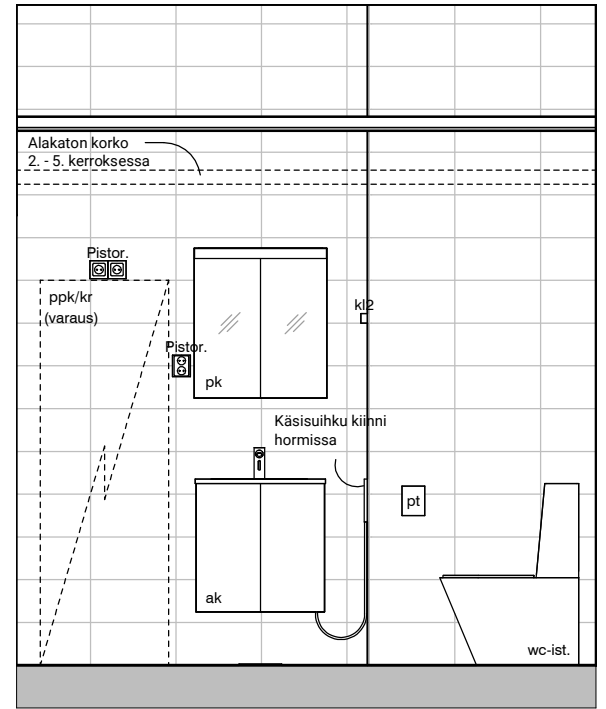
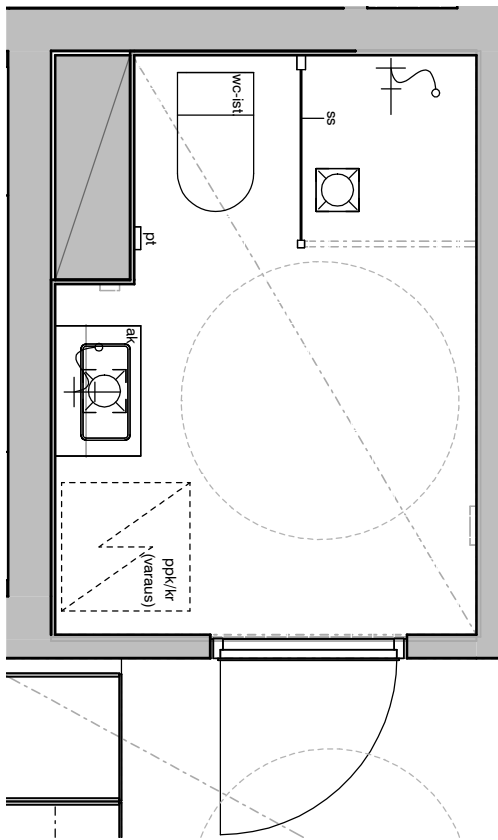

07d

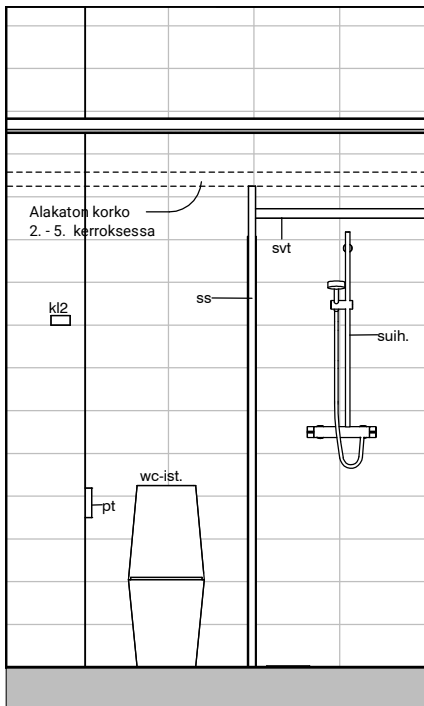

07a

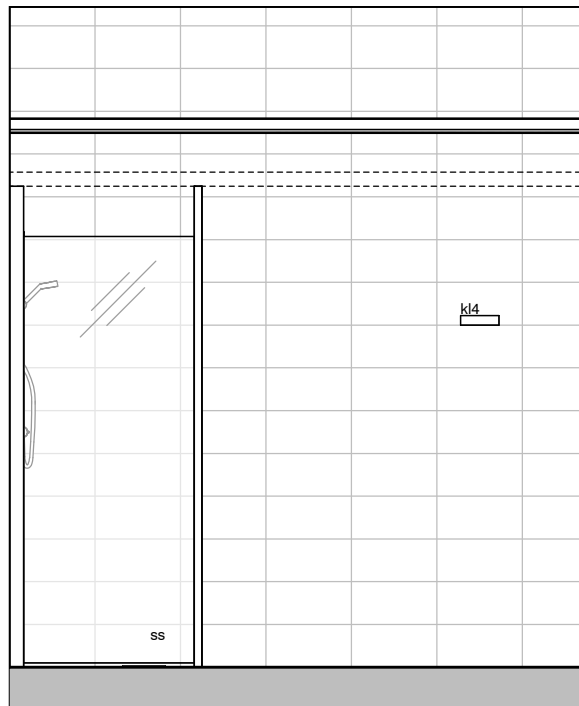

07b

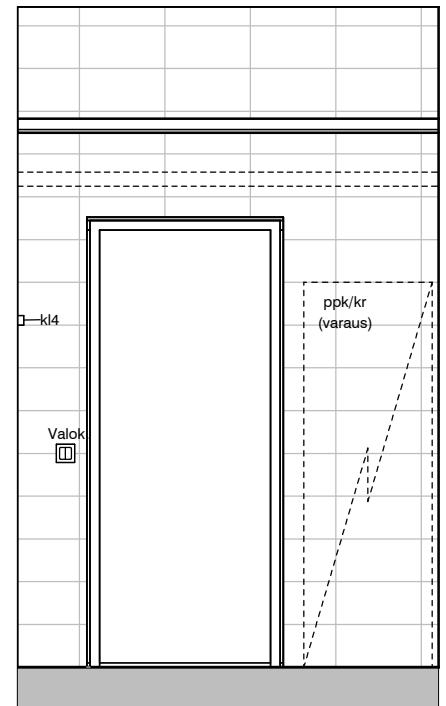

07c



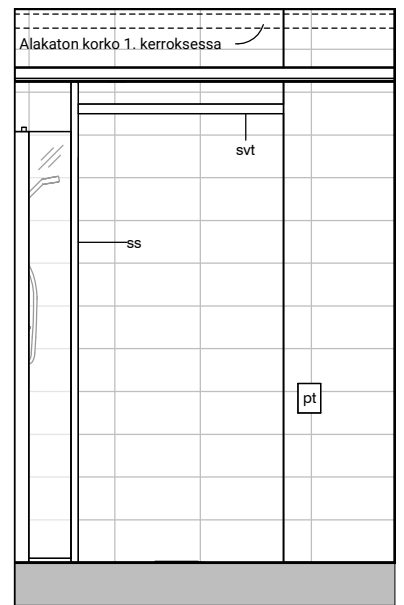
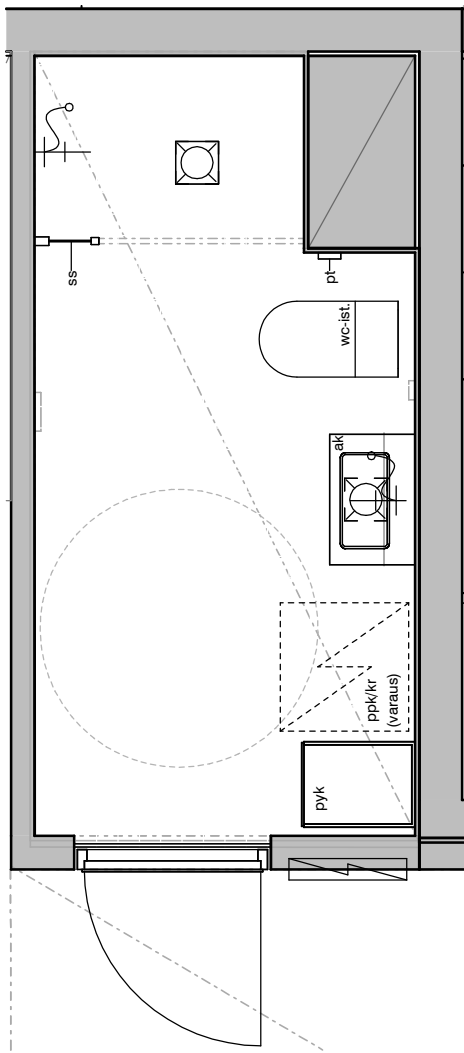

08a

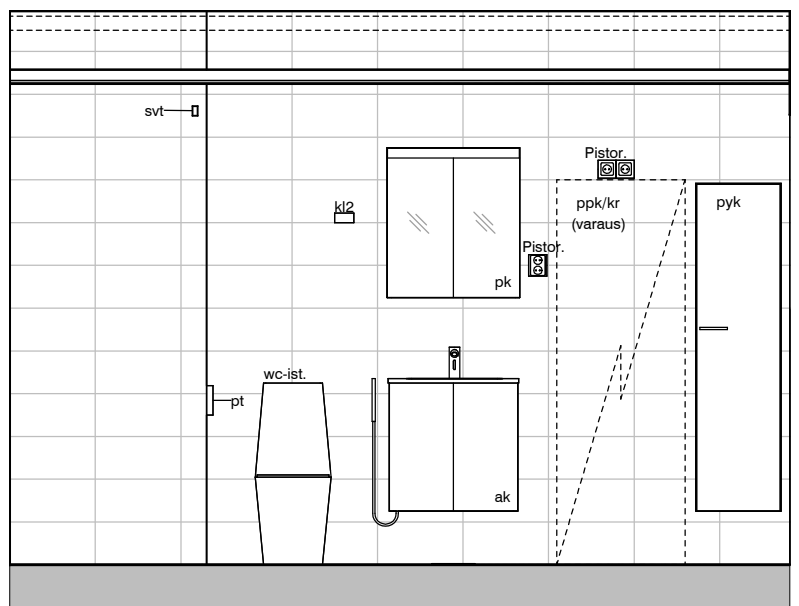

08b

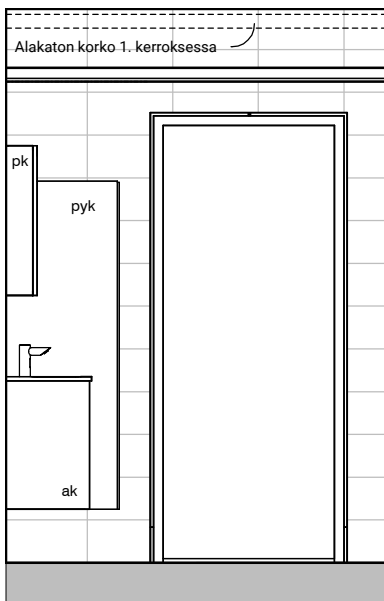

08c

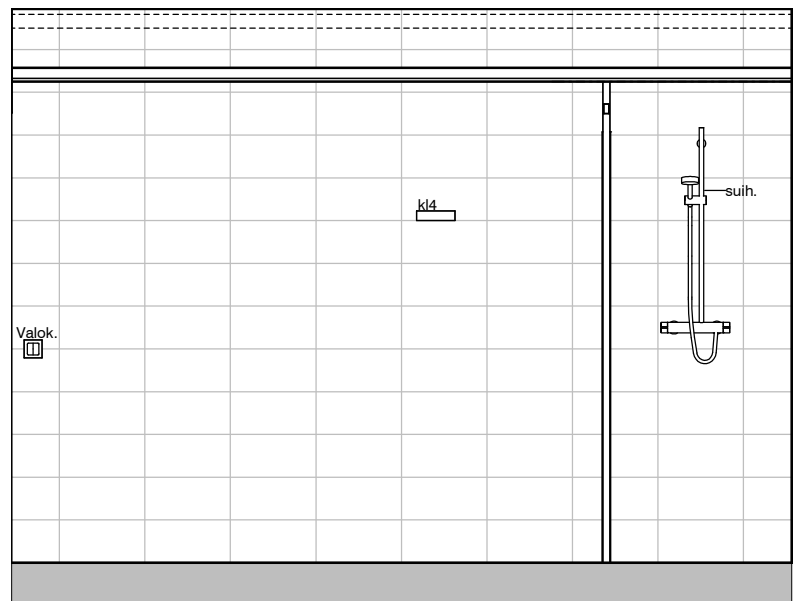

08d

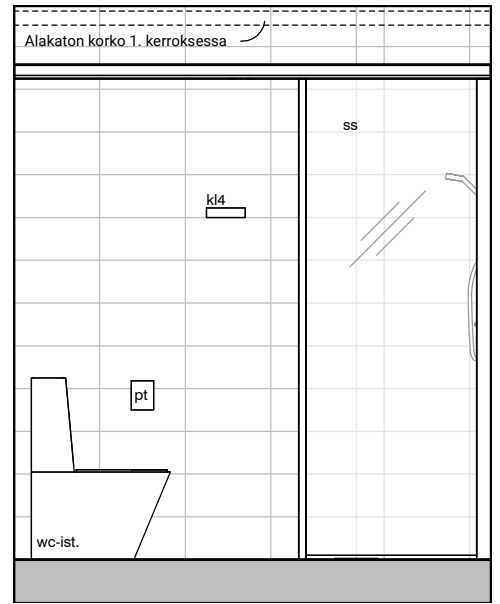
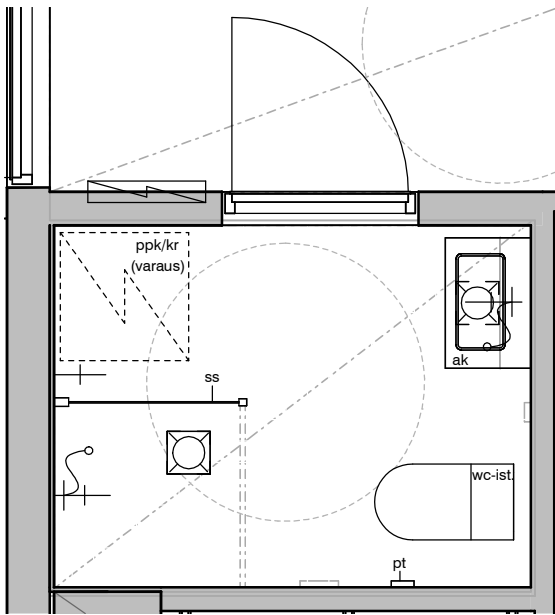

09a

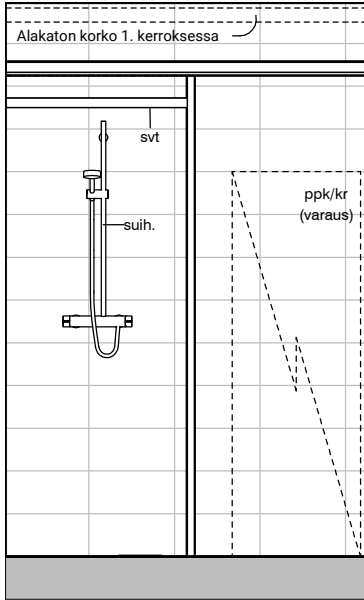

09b

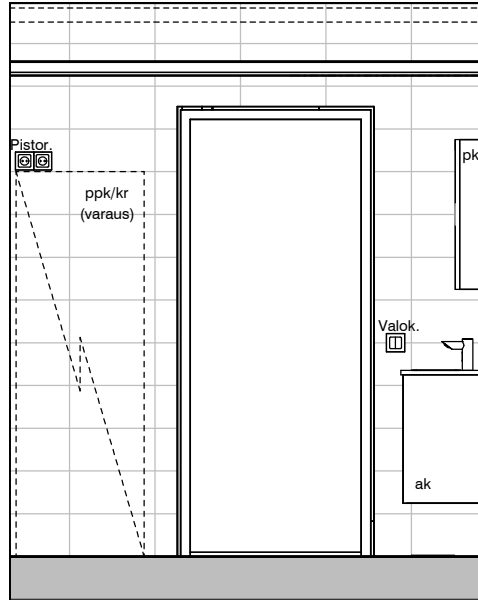

09c

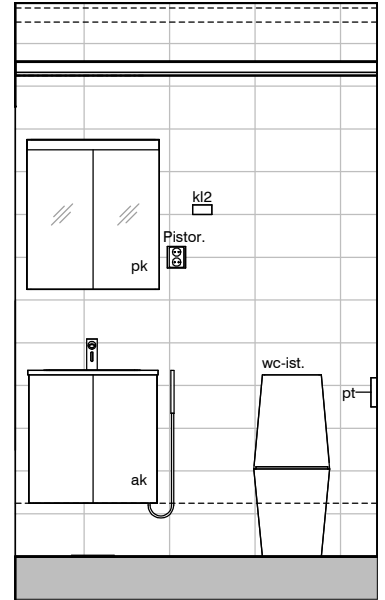

09d

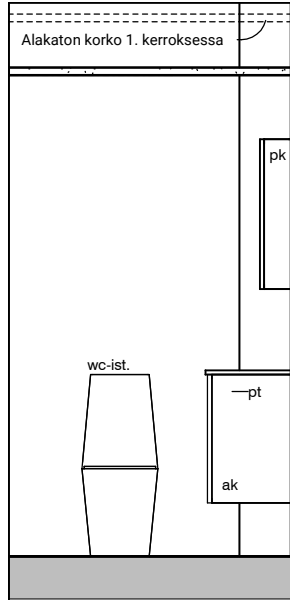
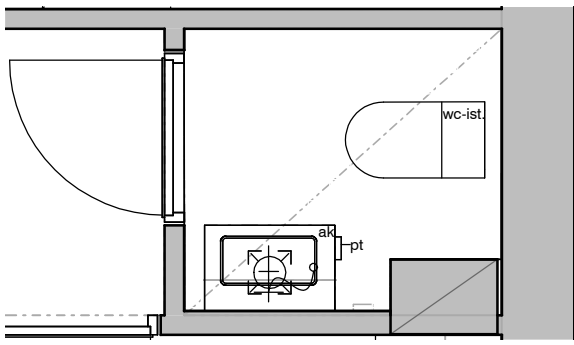

09f

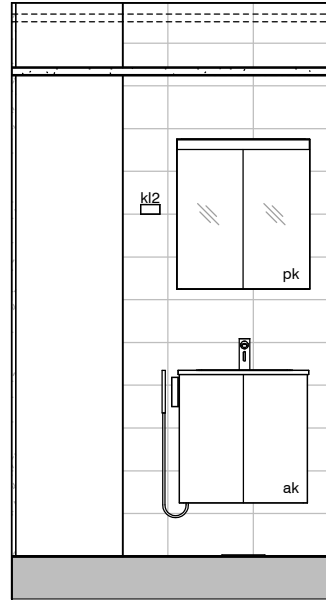

09g

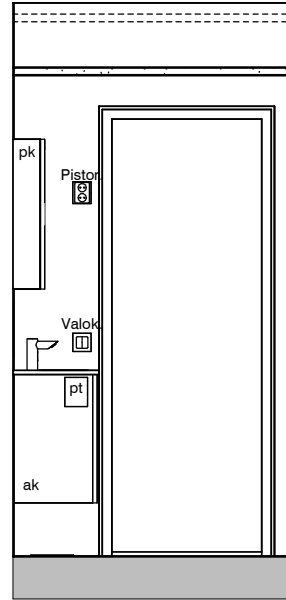

09h

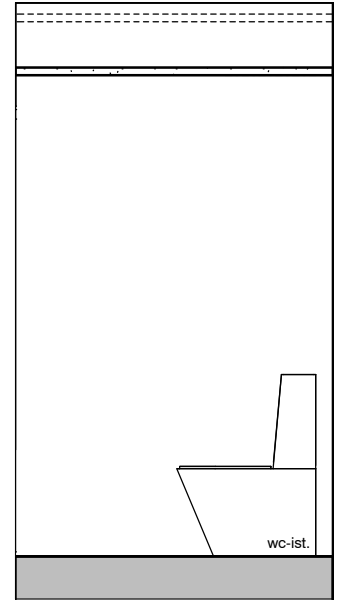

09i

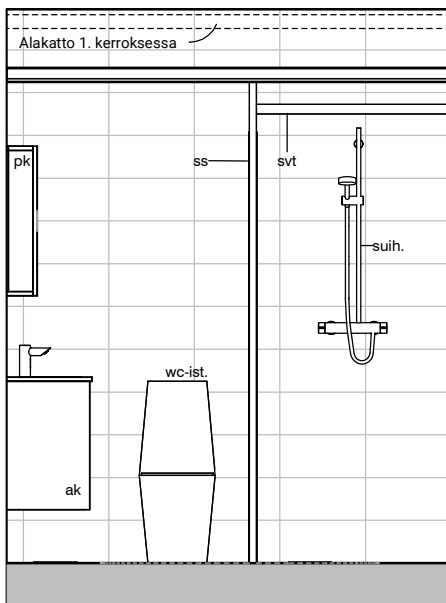
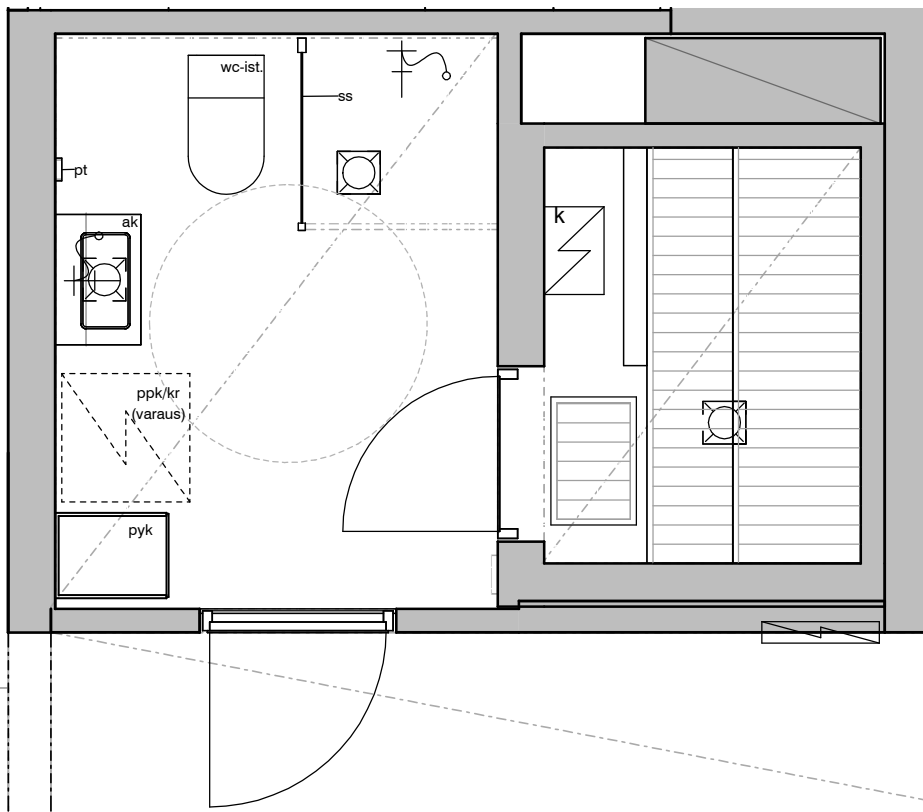

02a

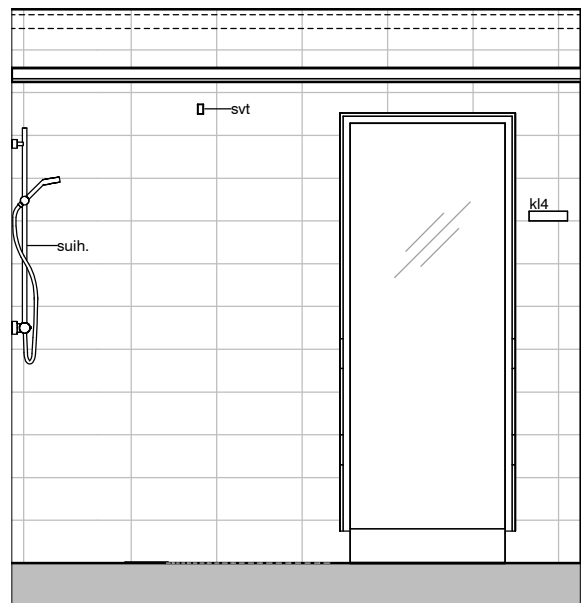

02b

Kylpyhuone ja sauna s.1  
Asunto C40

HASO Maapadontie 9  
Maapadontie 9  
00640  
Helsinki

Kaaviossa olevat tuotteiden kuvat esittävät niiden sijainteja. Kuvat ovat symboleita, tuotteet visuaalisesti esitetyt ja niihin liittyvät ratkaisut voivat poiketa kaaviossa esitetyistä. Pääosin tuotteet on esitetty "Asunnon materiaalivalinnat"-aineistossa. Kaavion mitat ovat moduulimittoja, todelliset mitat saatavat poiketa valmistajasta riippuen. Esitetyt alaslaskujen mitat ovat tavoitteellisia ja saattavat poiketa kuvassa esitetyistä mitoista talotekniikasta johtuvista syistä.

12.4.2024

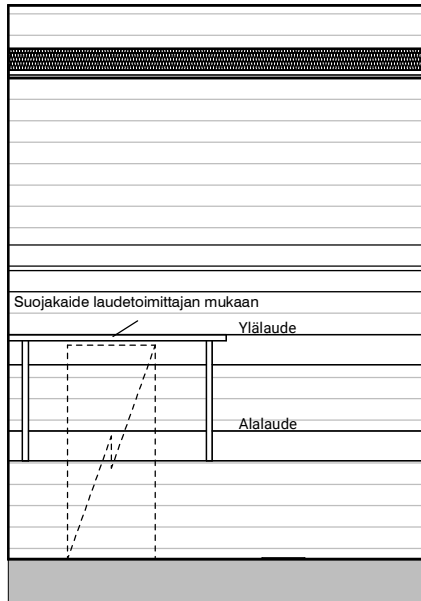

02e

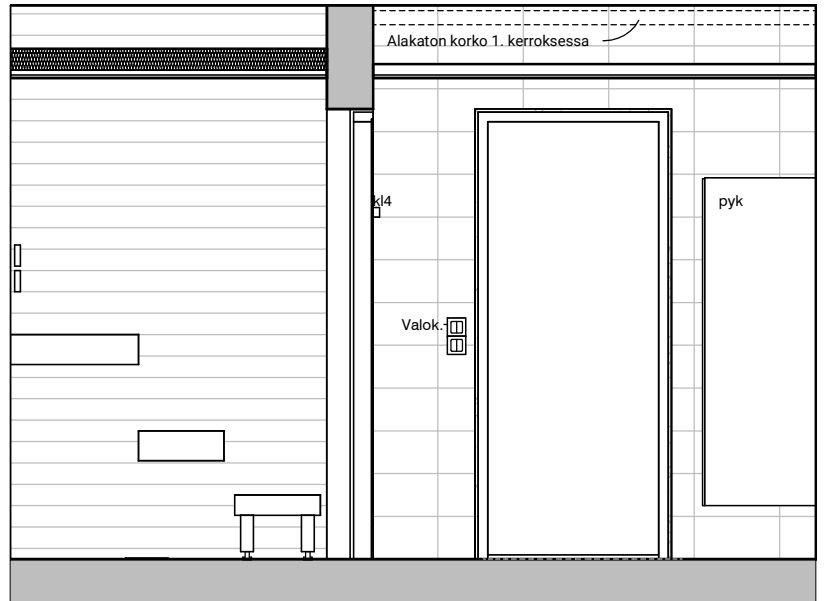

02c

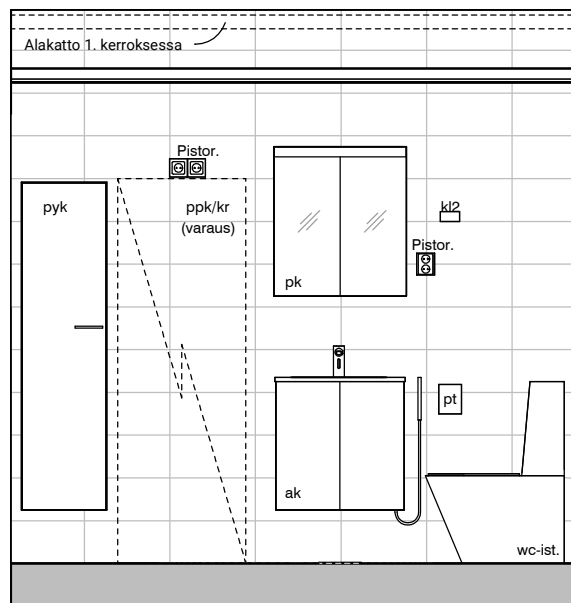

02d

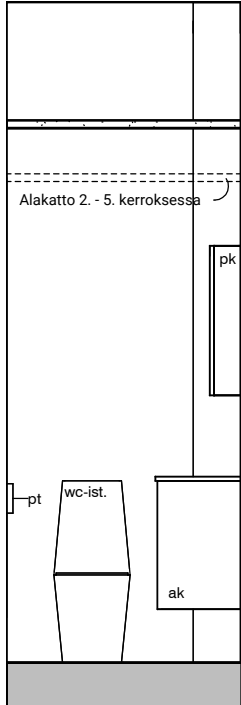
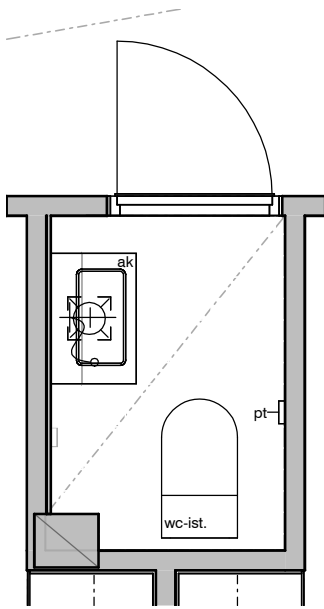

02j

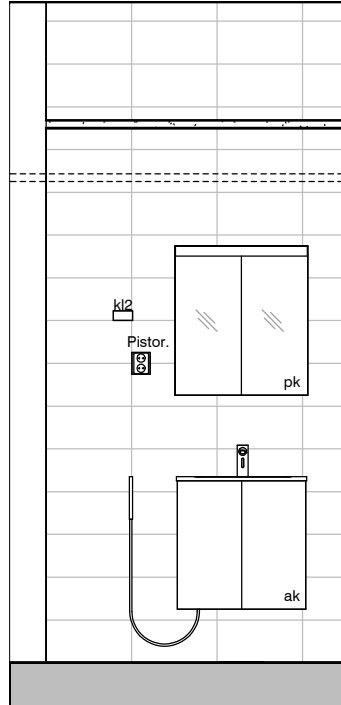

02k

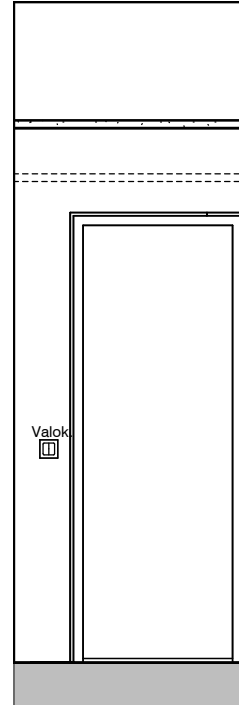

02l

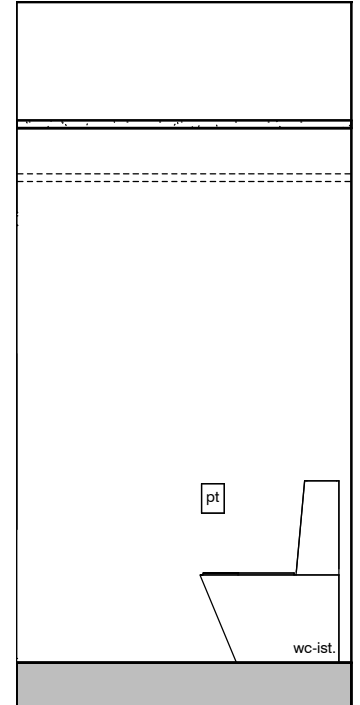

02m

Vessa  
Asunto C40

HASO Maapadontie 9  
Maapadontie 9  
00640  
Helsinki

Kaaviossa olevat tuotteiden kuvat esittävät niiden sijainteja.  
Kuvat ovat symboleita, tuotteet visuaalisesti esitettynä ja  
niihin liittyvät ratkaisut voivat poiketa kaaviossa esitetyistä.  
Pääosin tuotteet on esitetty "Asunnon materiaalivalinnat"-  
aineistossa. Kaavion mitat ovat moduulimittoja, todelliset  
mitat saattavat poiketa valmistajasta riippuen. Esitetyt  
alaslaskujen mitat ovat tavoitteellisia ja saattavat poiketa  
kuvassa esitetyistä mitoista talotekniikasta johtuvista syistä.

12.4.2024

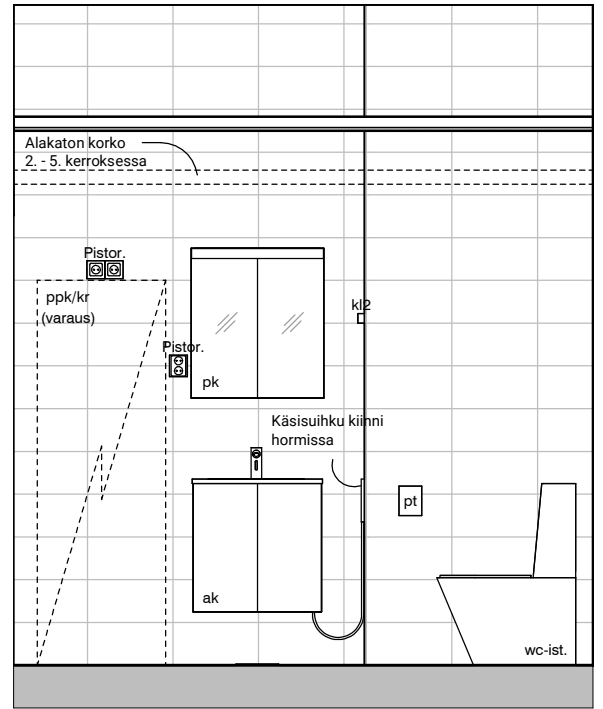
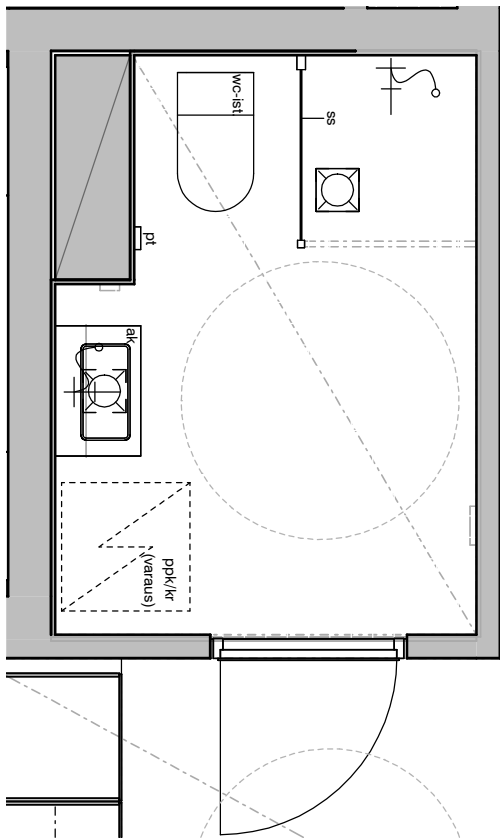

07d

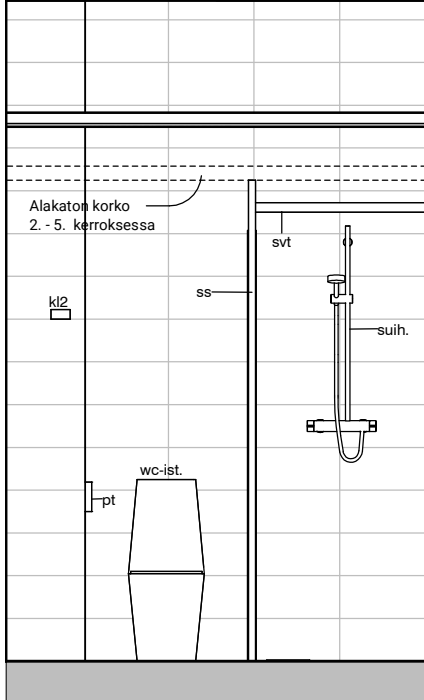

07a

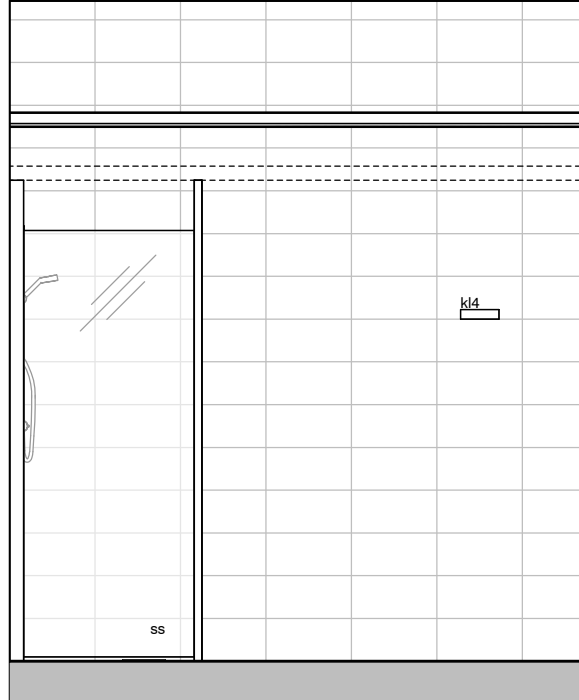

07b

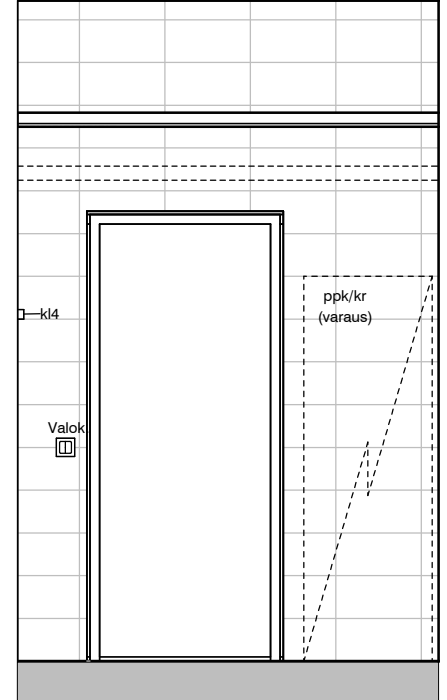

07c

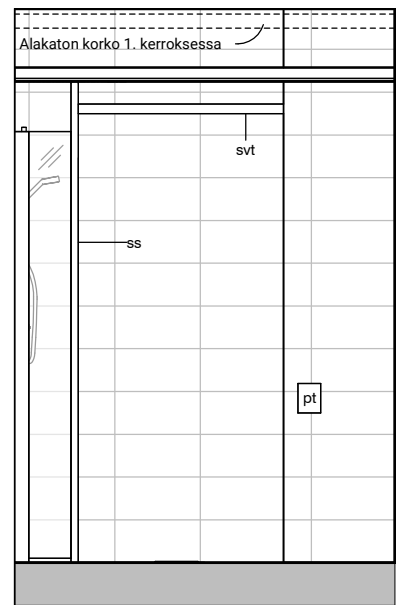
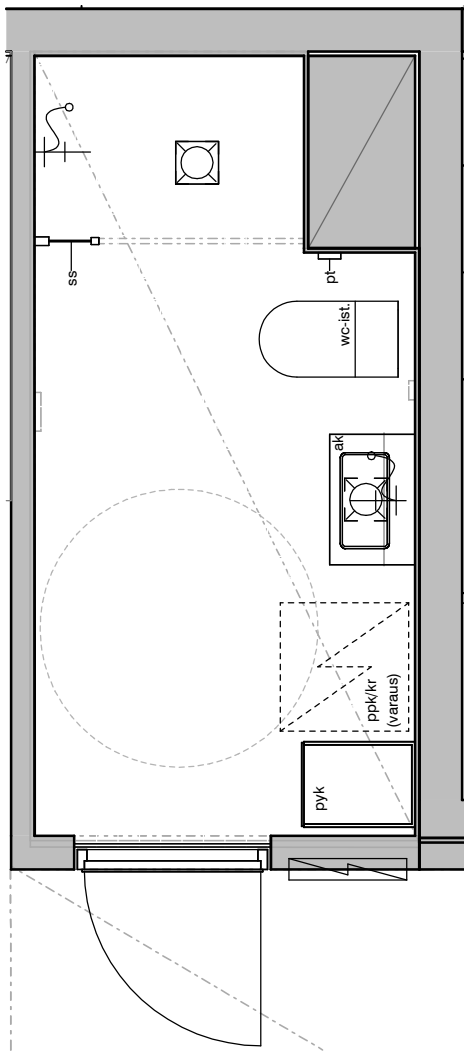

08a

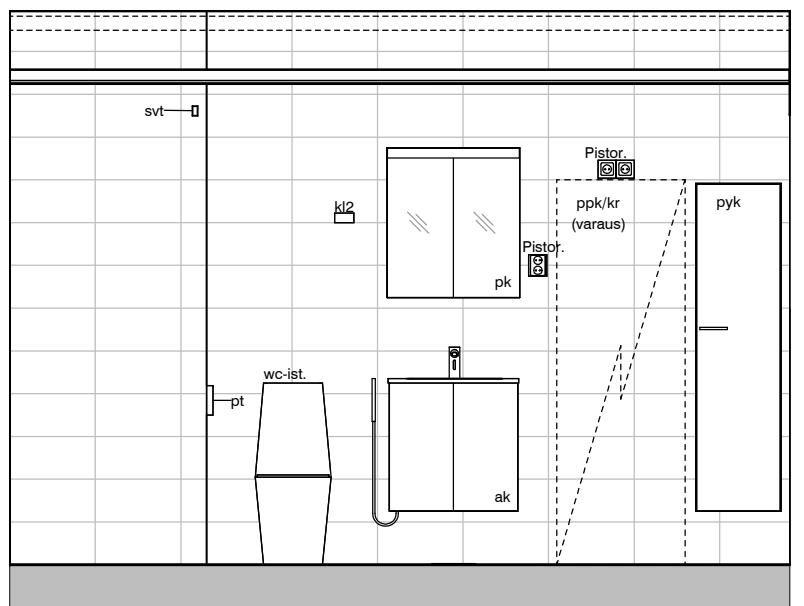

08b

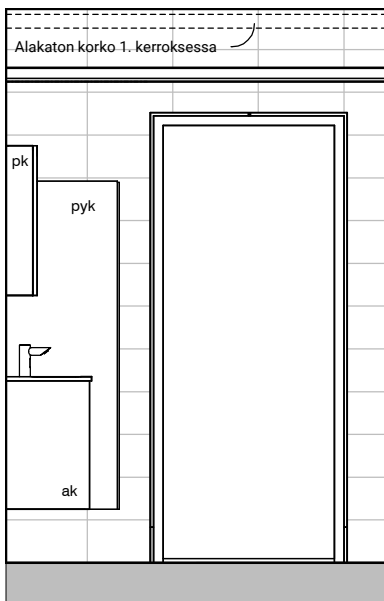

08c

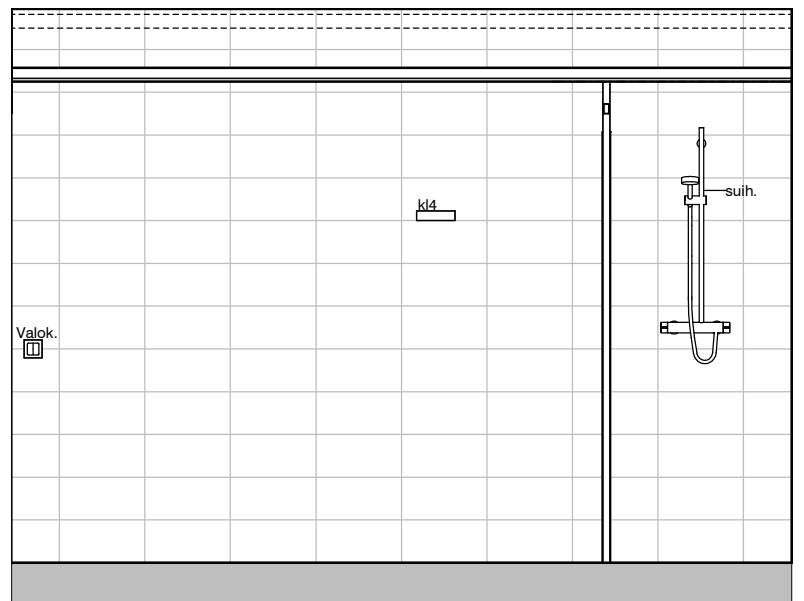

08d



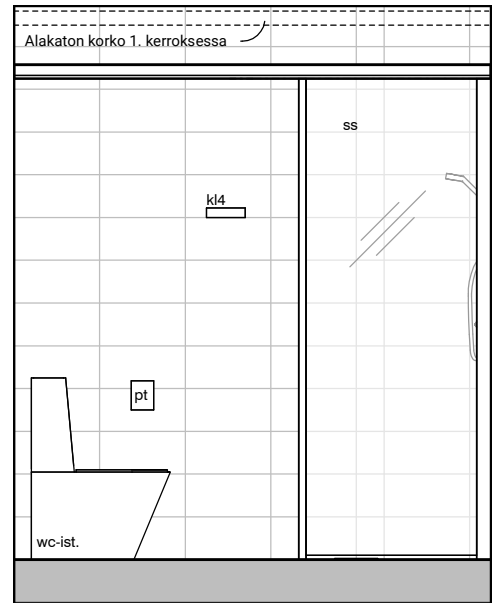
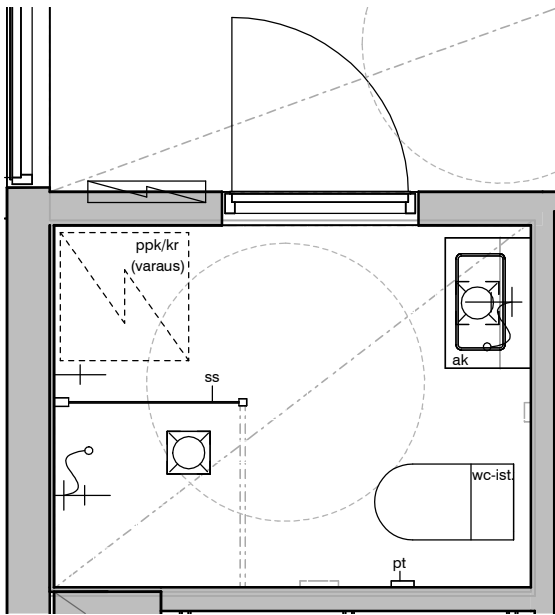

09a

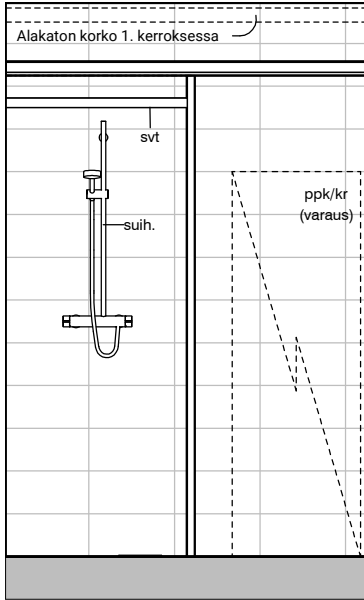

09b

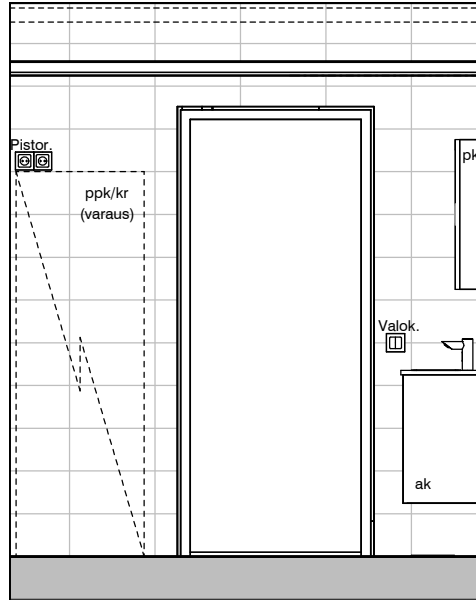

09c

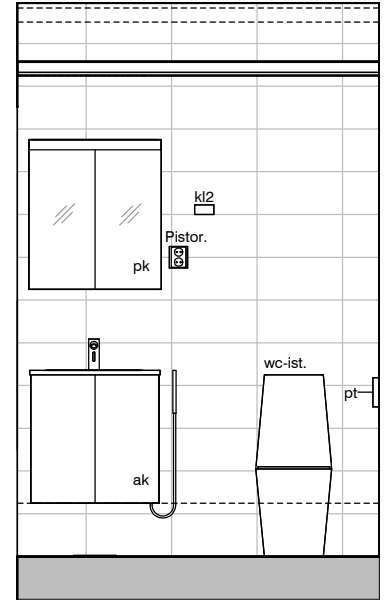

09d

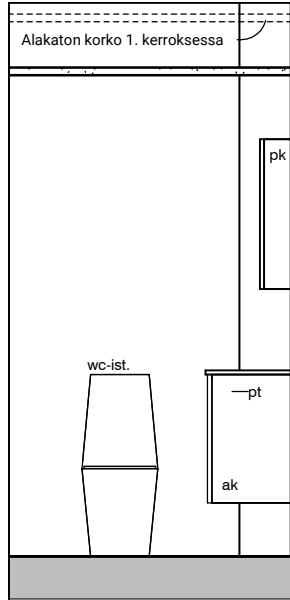
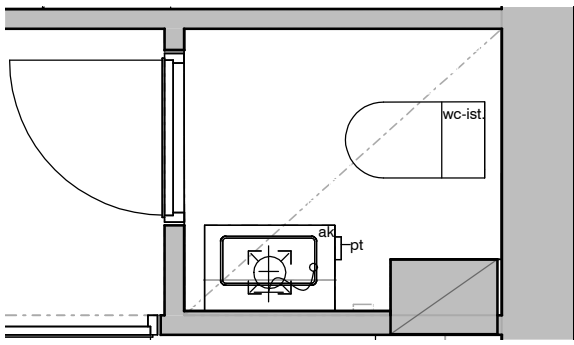

09f

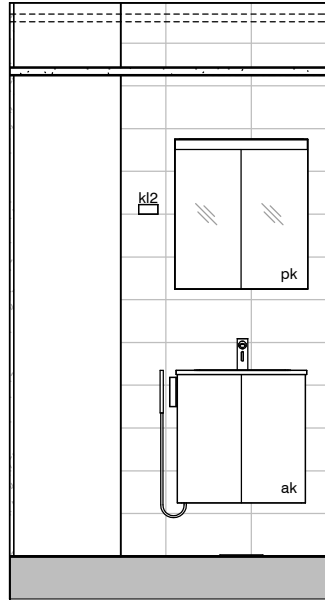

09g

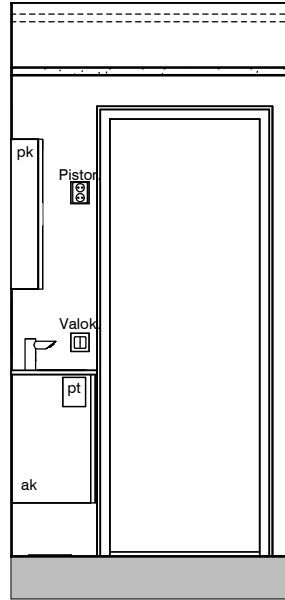

09h

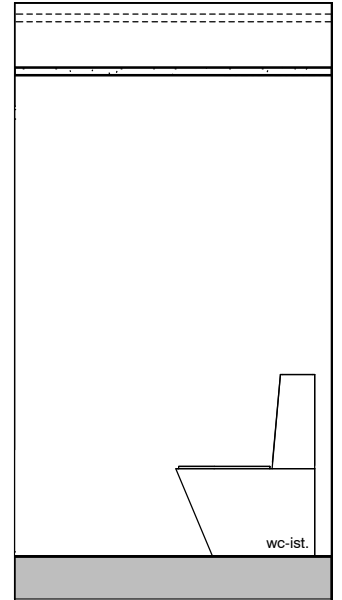

09i

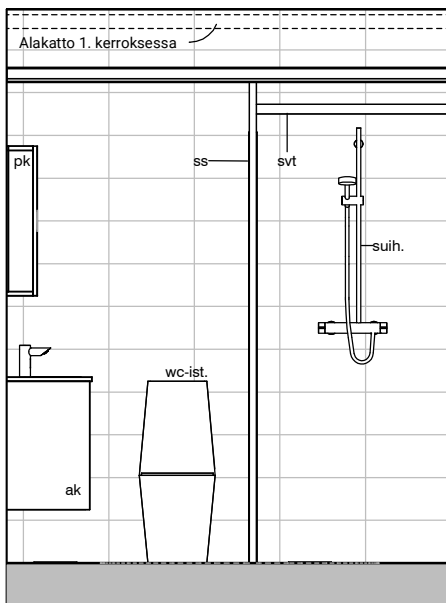
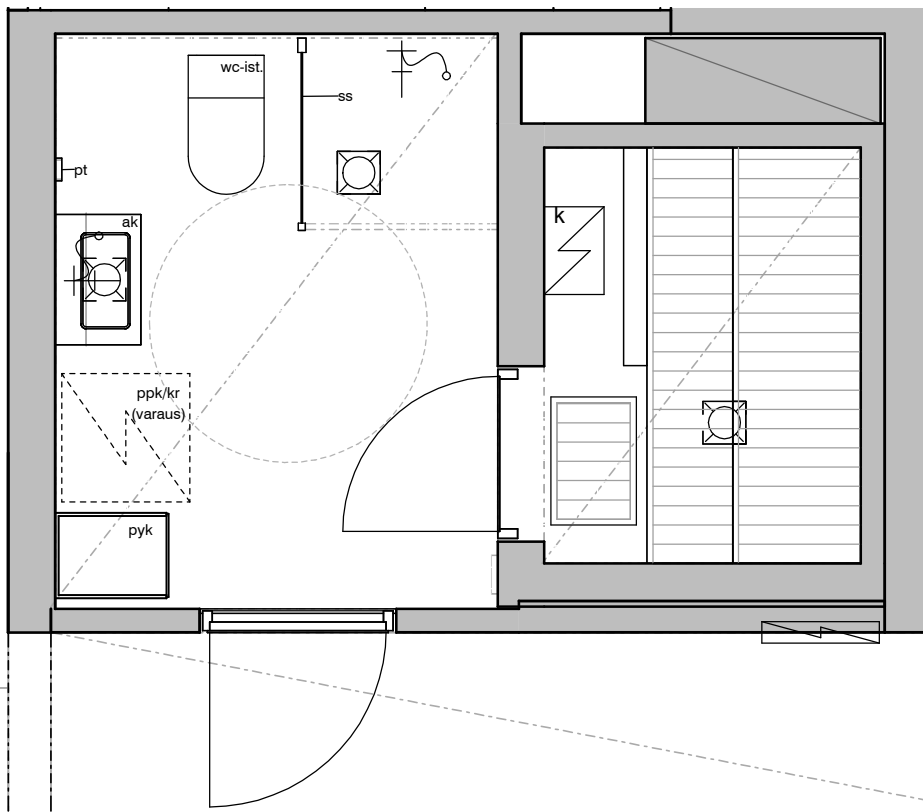

02a

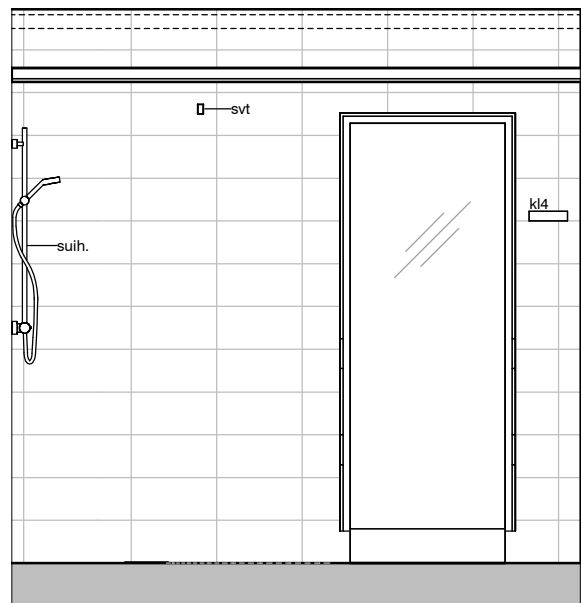

02b

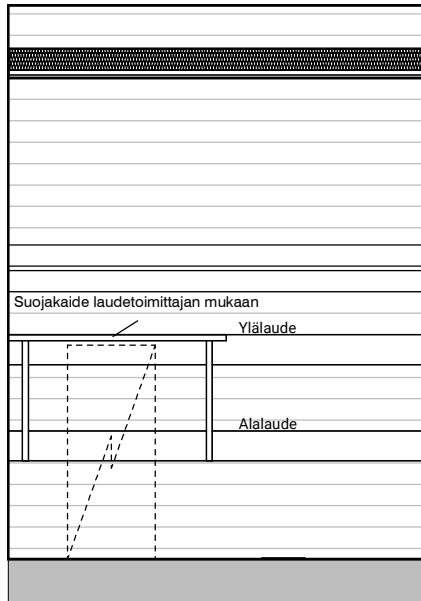

02e

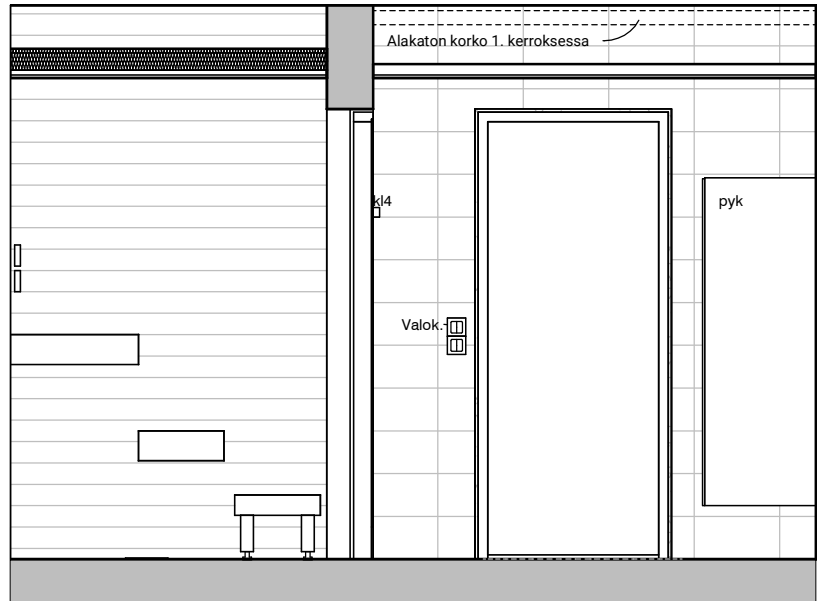

02c

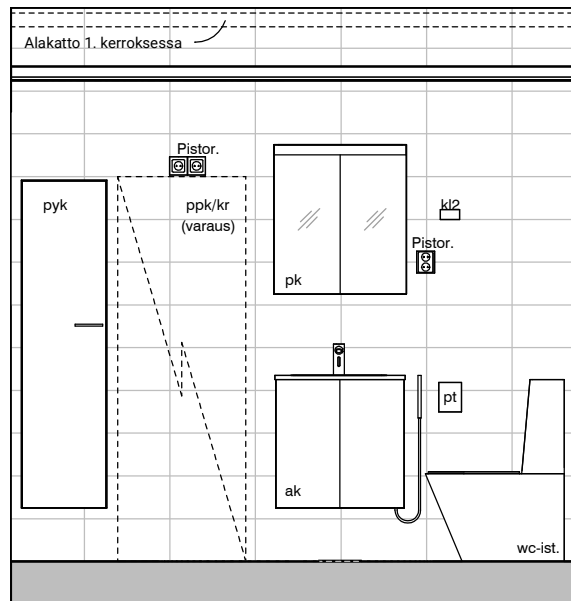

02d

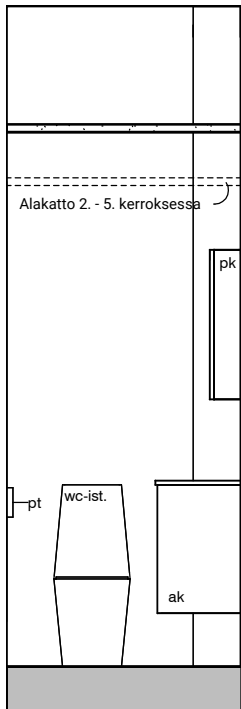
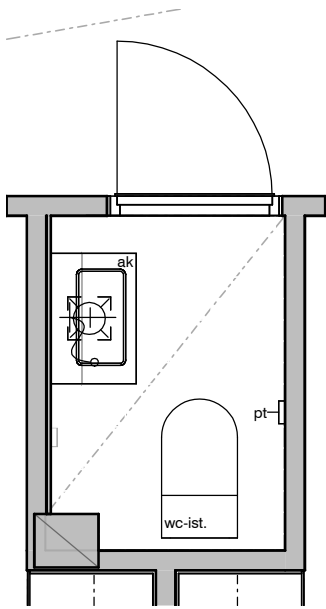

02j

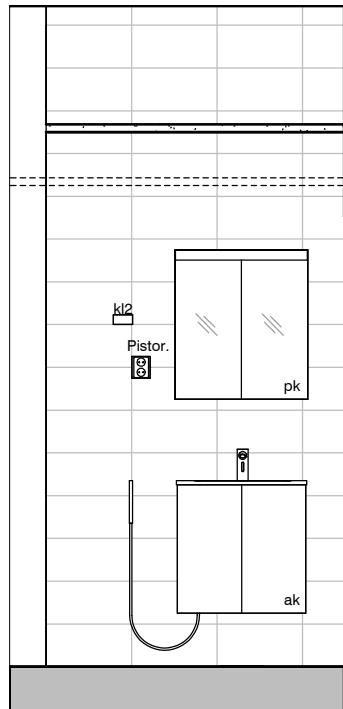

02k

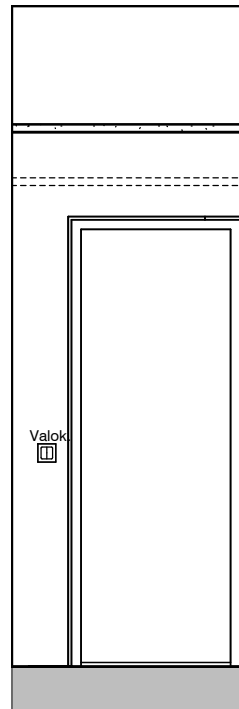

02l

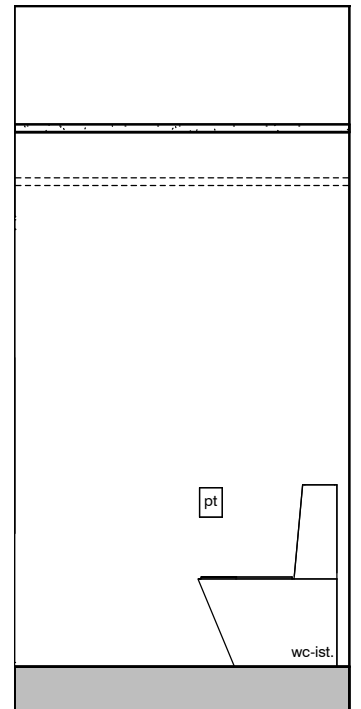

02m

Vessa  
Asunto C44

HASO Maapadontie 9  
Maapadontie 9  
00640  
Helsinki

Kaaviossa olevat tuotteiden kuvat esittävät niiden sijainteja.  
Kuvat ovat symboleita, tuotteet visuaalisesti esitettävä ja  
niihin liittyvät ratkaisut voivat poiketa kaaviossa esitetyistä.  
Pääosin tuotteet on esitetty "Asunnon materiaalivalinnat"-  
aineistossa. Kaavion mitat ovat moduulimittoja, todelliset  
mitat saattavat poiketa valmistajasta riippuen. Esitetyt  
alaslaskujen mitat ovat tavoitteellisia ja saattavat poiketa  
kuvassa esitetyistä mitoista talotekniikasta johtuvista syistä.

12.4.2024

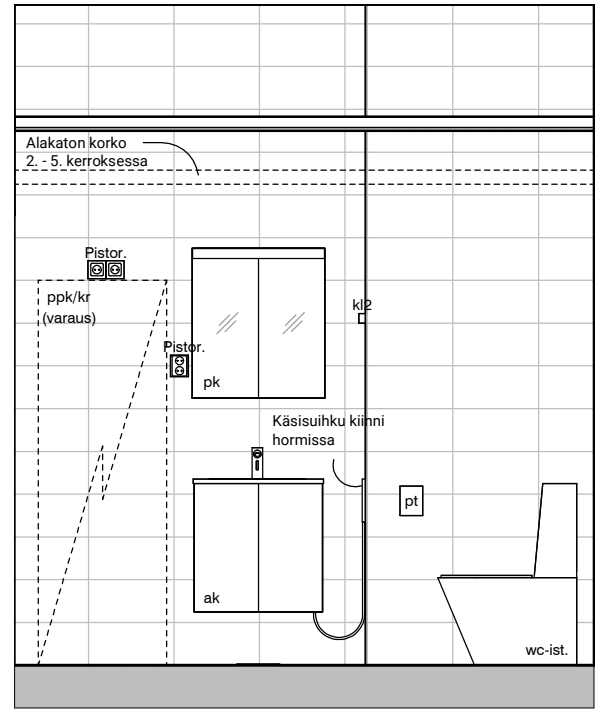
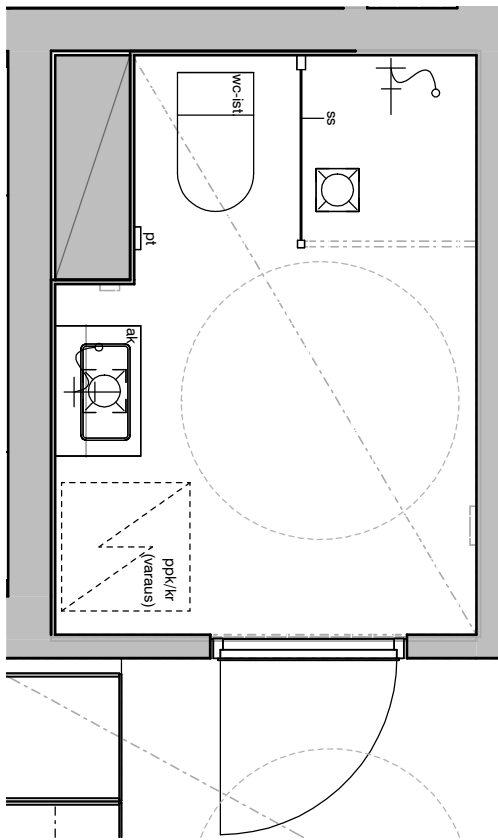

07d

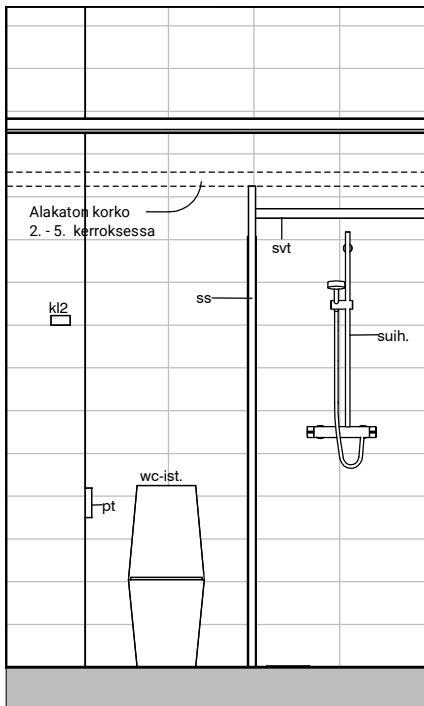

07a

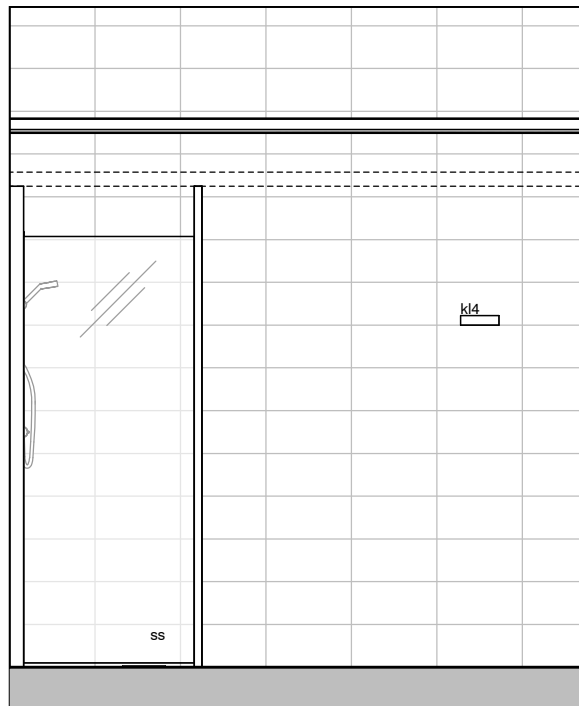

07b

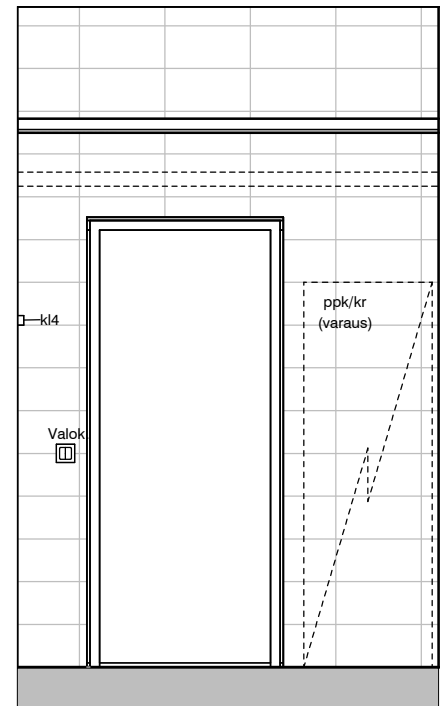

07c

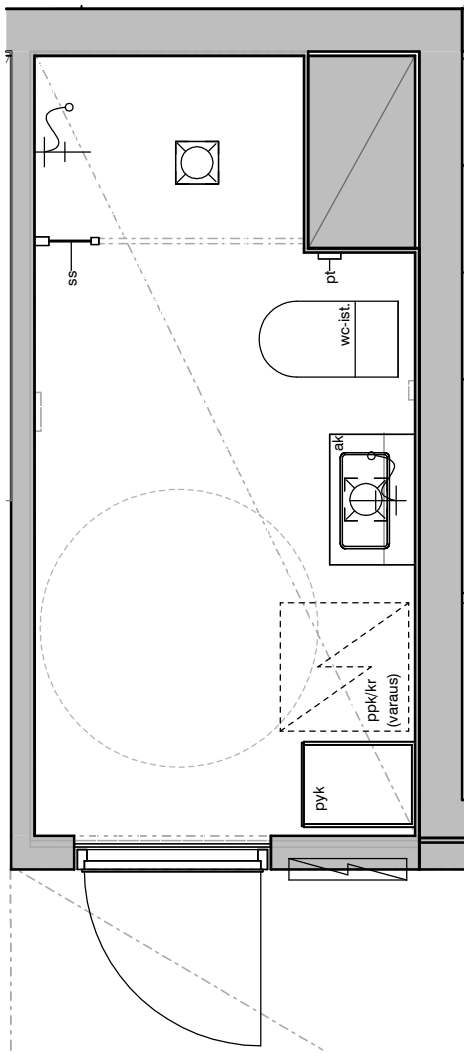

08a

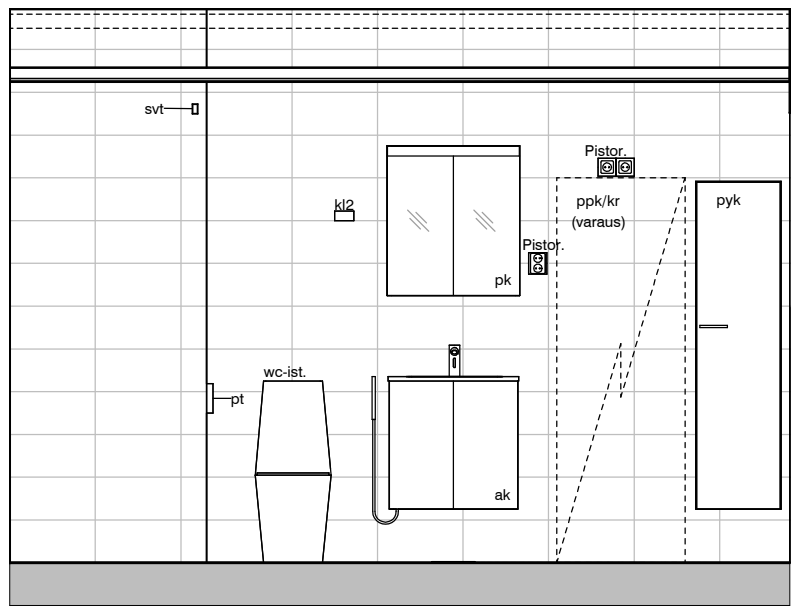
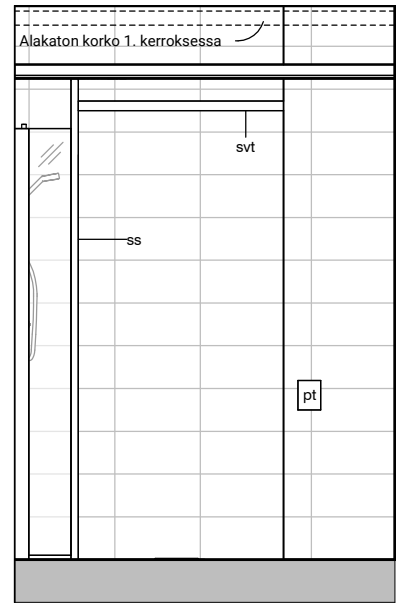

08b

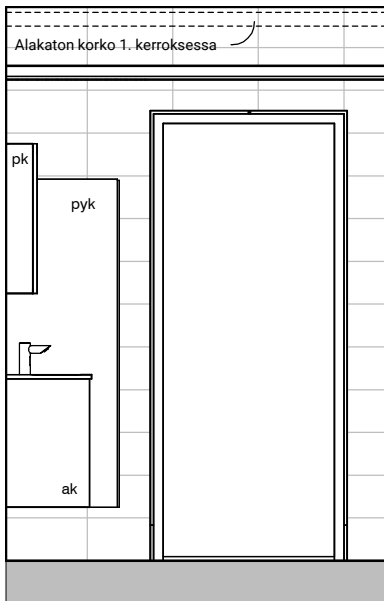

08c

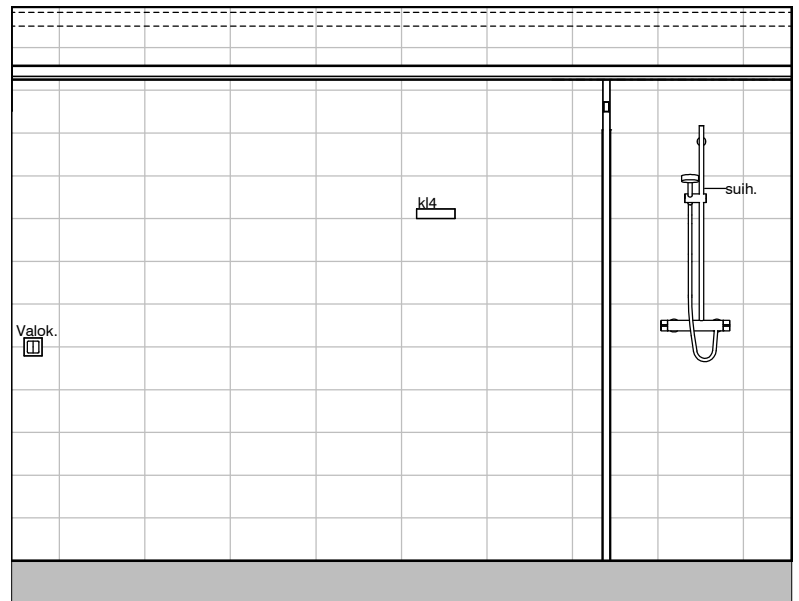

08d

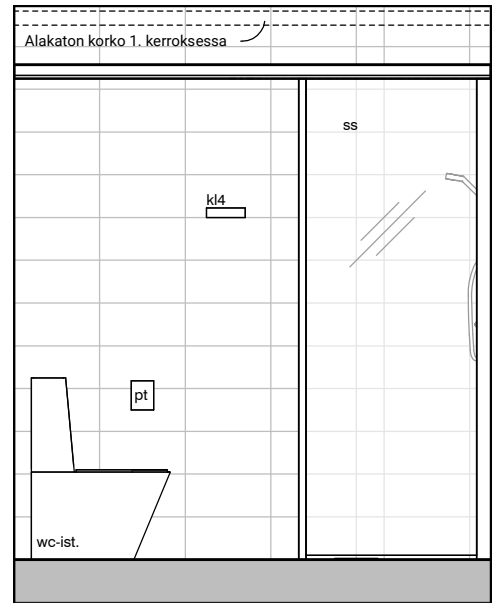
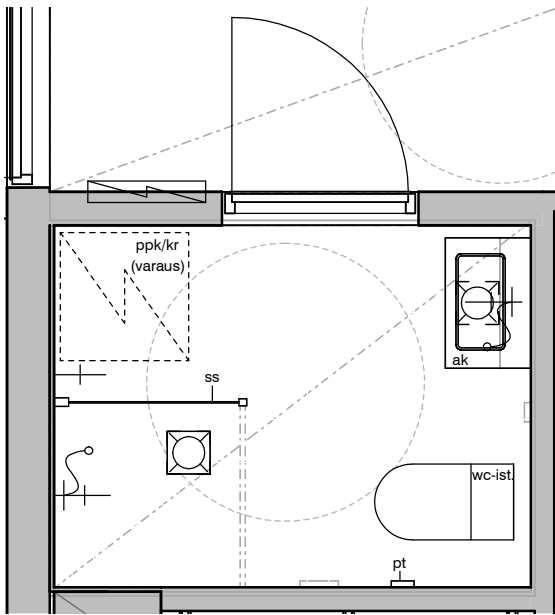

09a

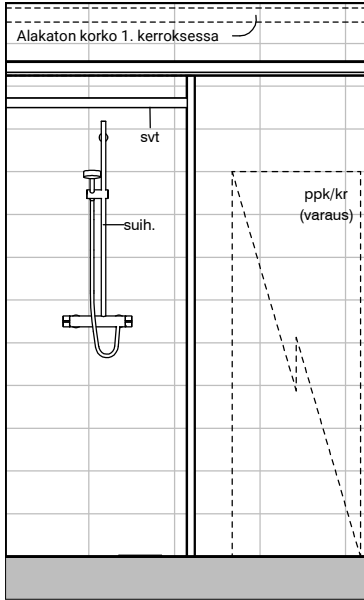

09b

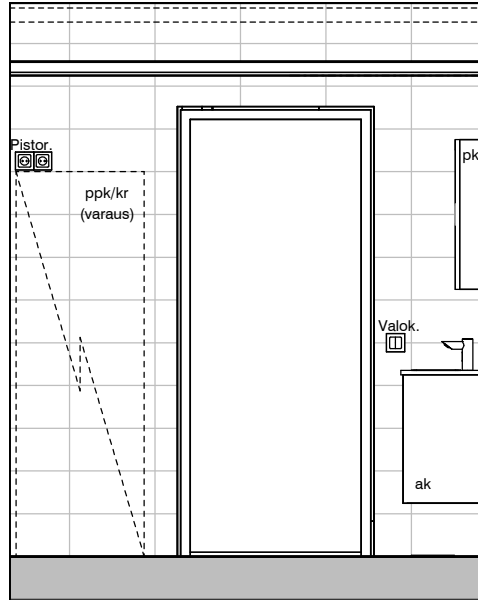

09c

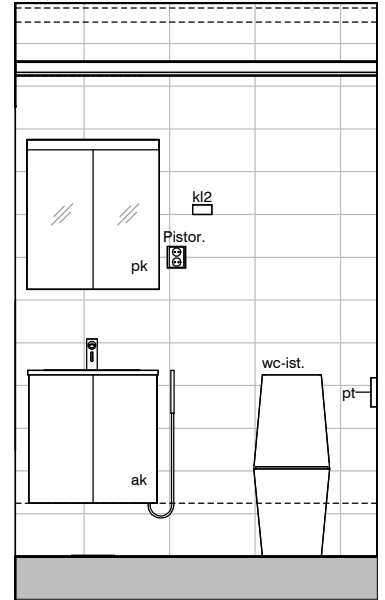

09d

Kylpyhuone  
Asunto C47

HASO Maapadontie 9  
Maapadontie 9  
00640  
Helsinki

Kaaviossa olevat tuotteiden kuvat esittävät niiden sijainteja. Kuvat ovat symboleita, tuotteet visuaalisesti esitettyjä ja niihin liittyvät ratkaisut voivat poiketa kaaviossa esitetystä. Pääosin tuotteet on esitetty "Asunnon materiaalivalinnat"-aineistossa. Kaavion mitat ovat moduulimittoja, todelliset mitat saattavat poiketa valmistajasta riippuen. Esitetyt alaslaskujen mitat ovat tavoitteellisia ja saattavat poiketa kuvassa esitetystä mitoista taloteknisistä johtuvista syistä.

12.4.2024



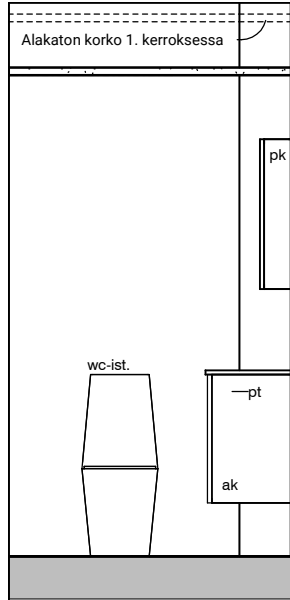
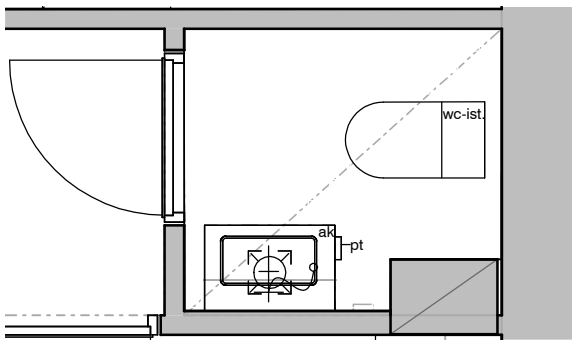

09f

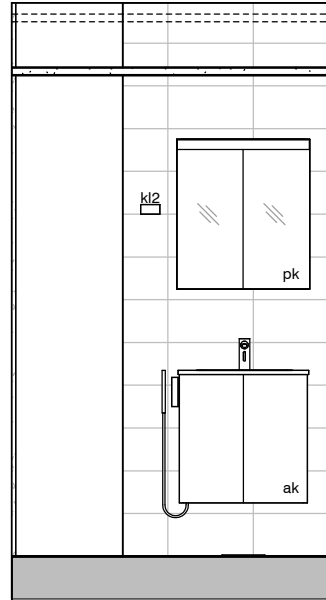

09g

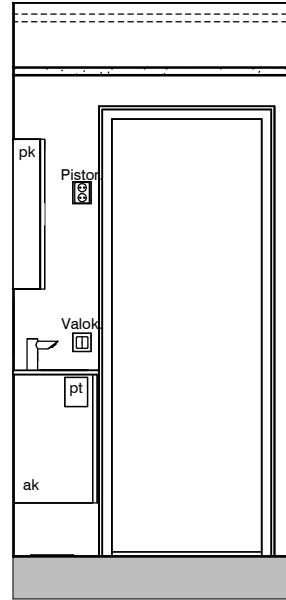

09h

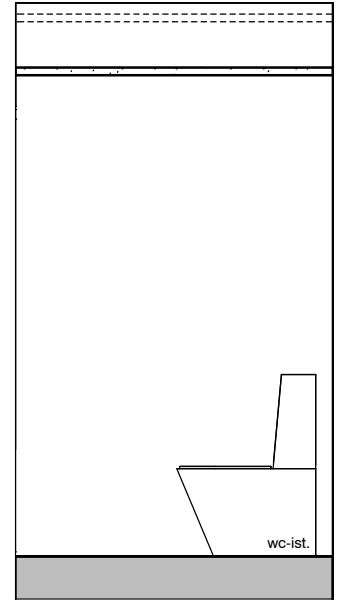

09i

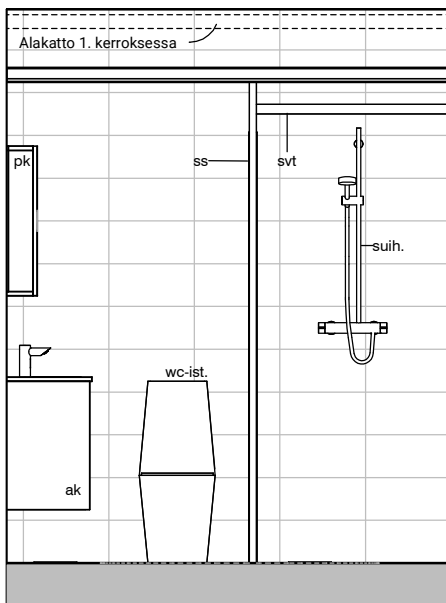
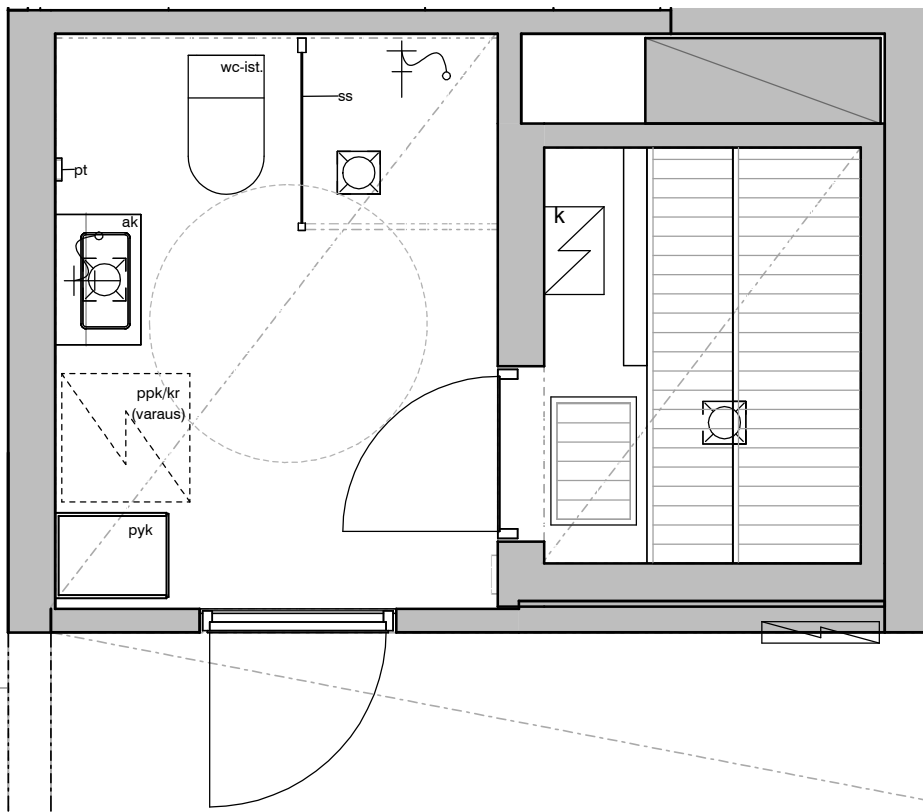

02a

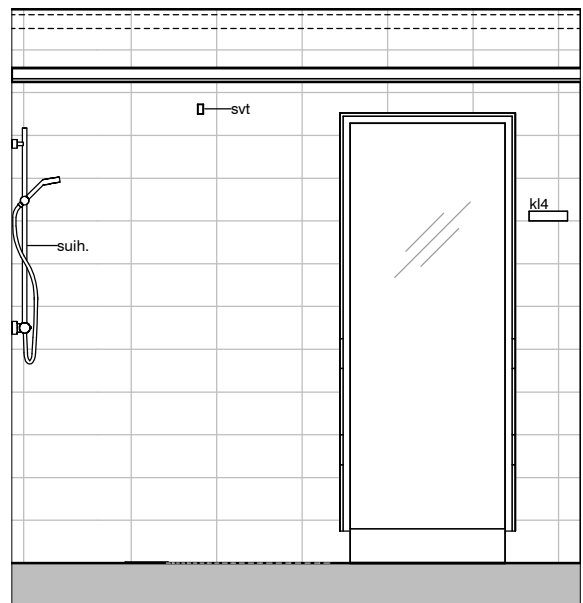

02b

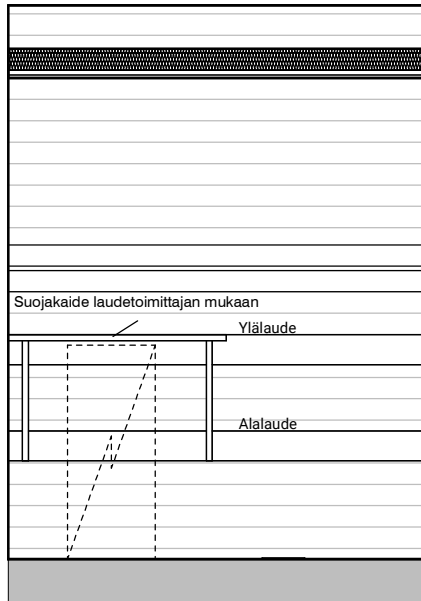

02e

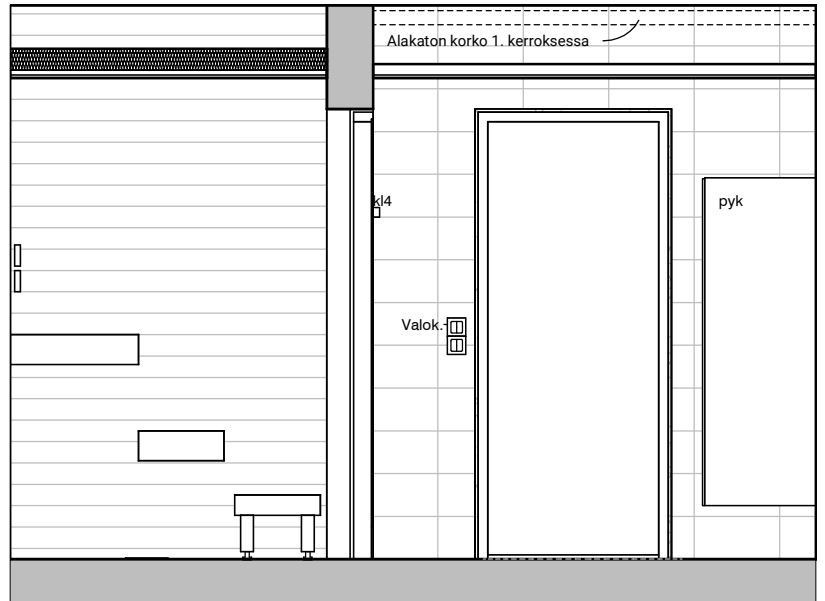

02c

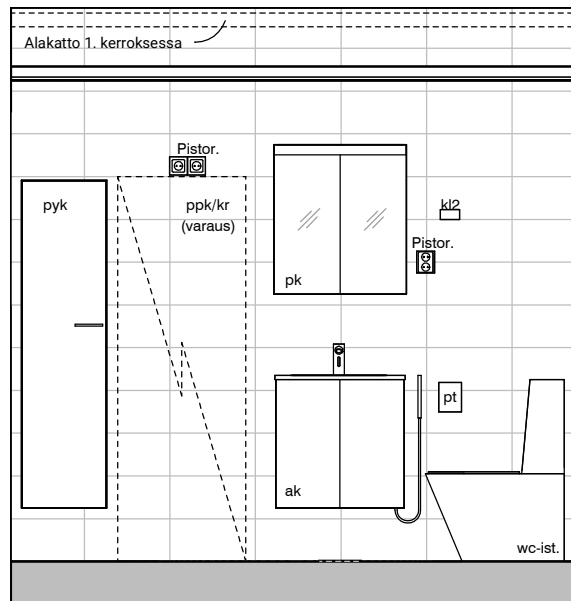

02d

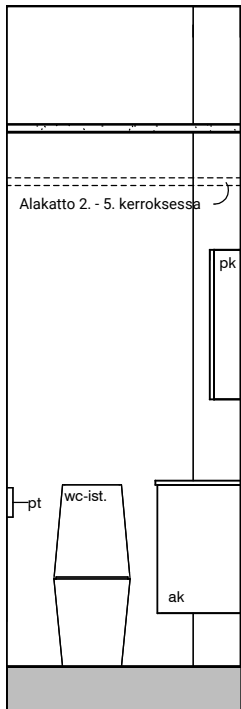
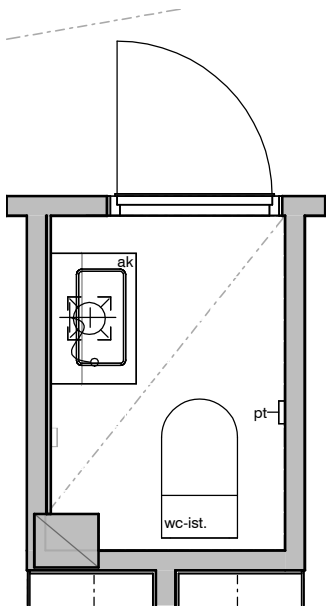

02j

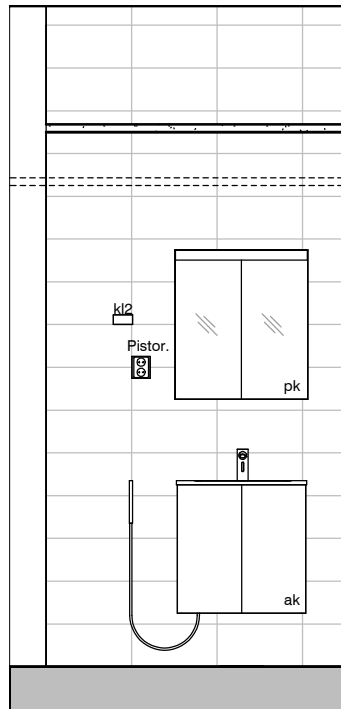

02k

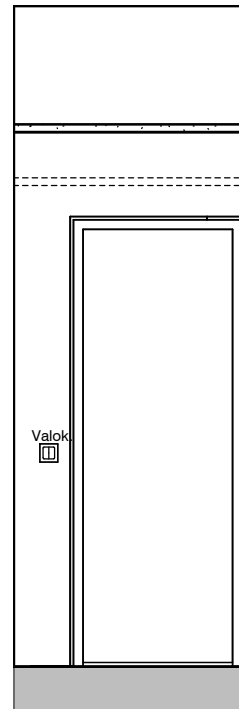

02l

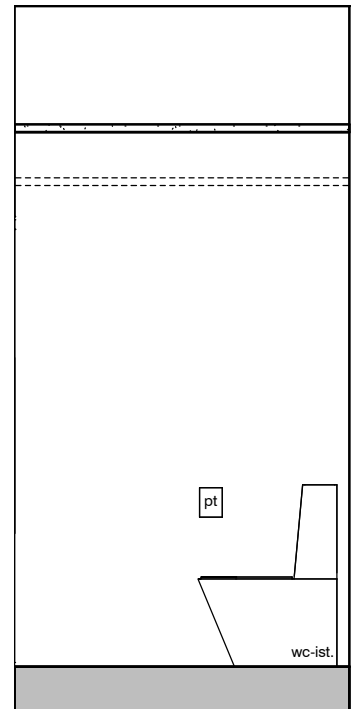

02m

Vessa  
Asunto C48

HASO Maapadontie 9  
Maapadontie 9  
00640  
Helsinki

Kaaviossa olevat tuotteiden kuvat esittävät niiden sijainteja.  
Kuvat ovat symboleita, tuotteet visuaalisesti esitettyjä ja  
niihin liittyvät ratkaisut voivat poiketa kaaviossa esitetystä.  
Pääosin tuotteet on esitetty "Asunnon materiaalivalinnat"  
aineistossa. Kaavion mitat ovat moduulimittoja, todelliset  
mitat saattavat poiketa valmistajasta riippuen. Esitetyt  
alaslaskujen mitat ovat tavoitteellisia ja saattavat poiketa  
kuvassa esitetystä mitoista taloteknisistä johtuvista syistä.

12.4.2024

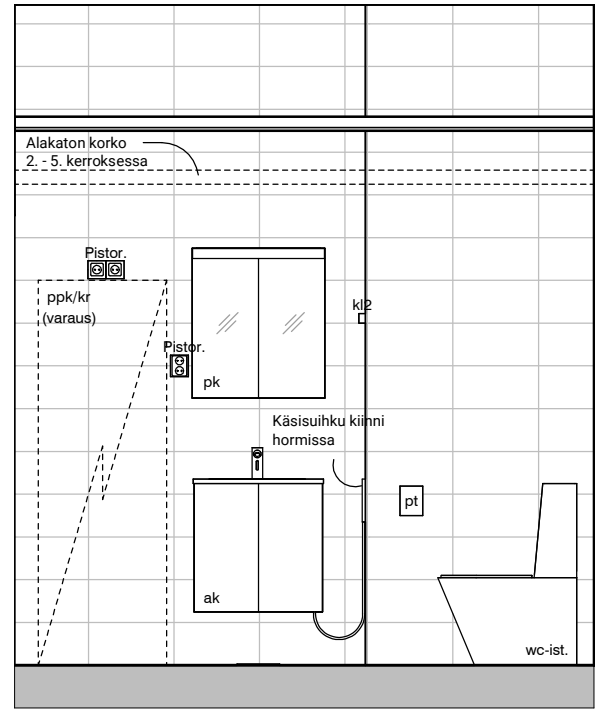
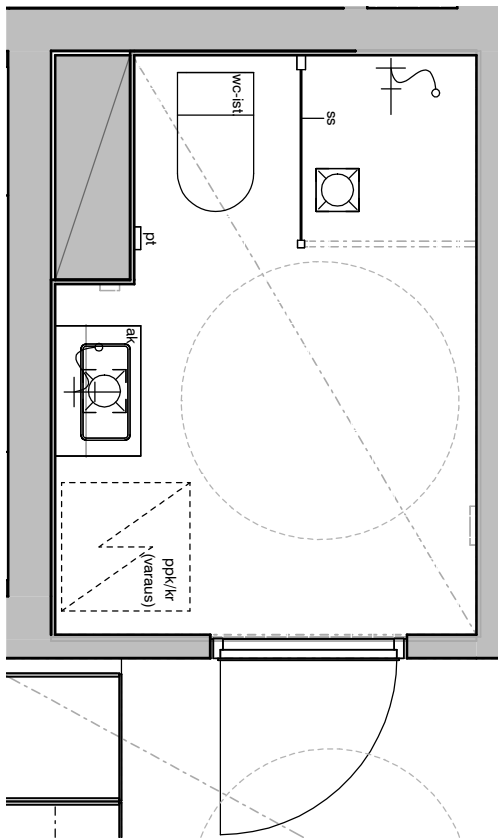

07d

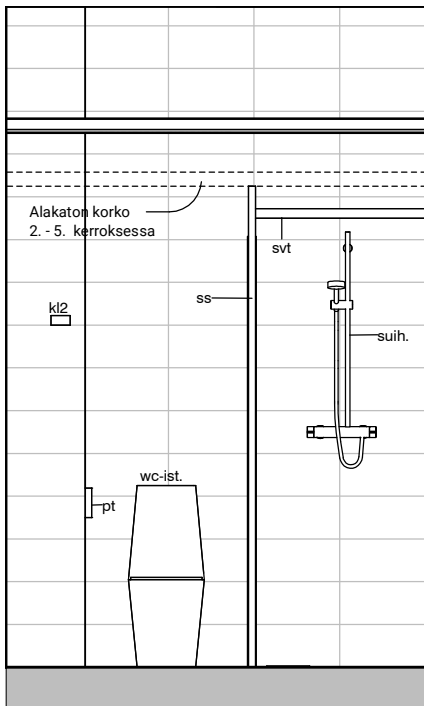

07a

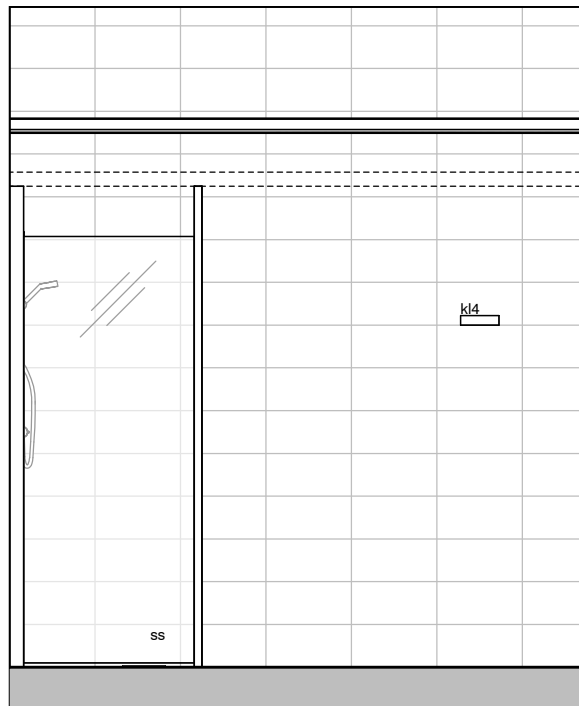

07b

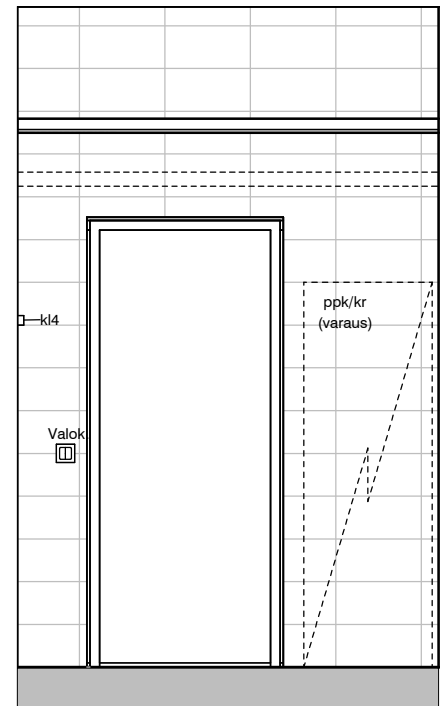

07c

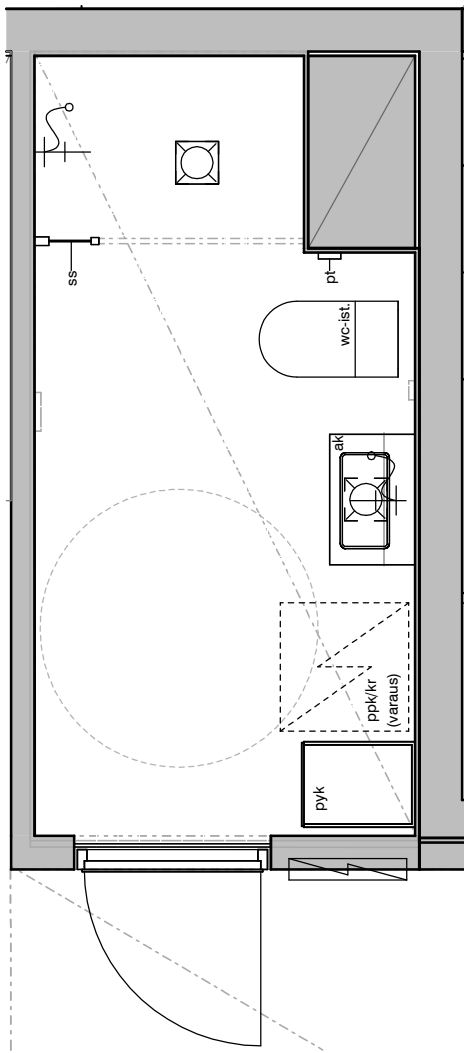

08a

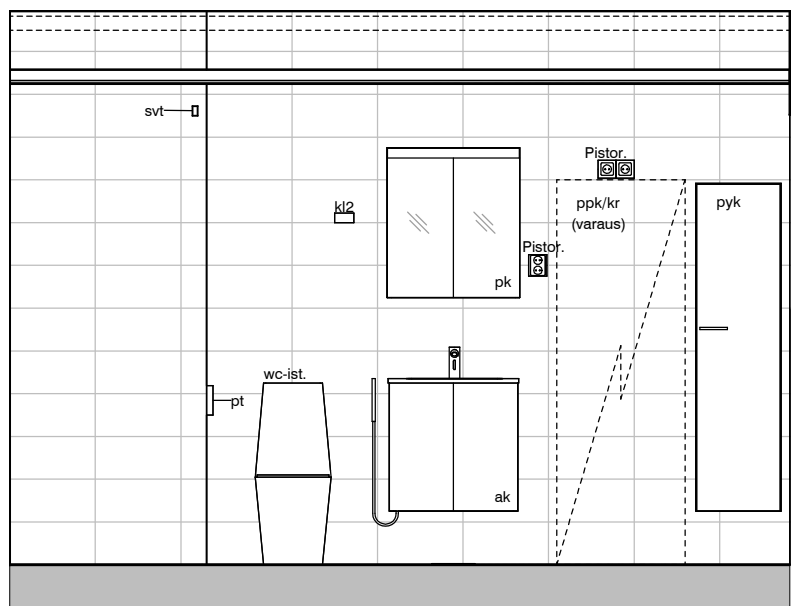
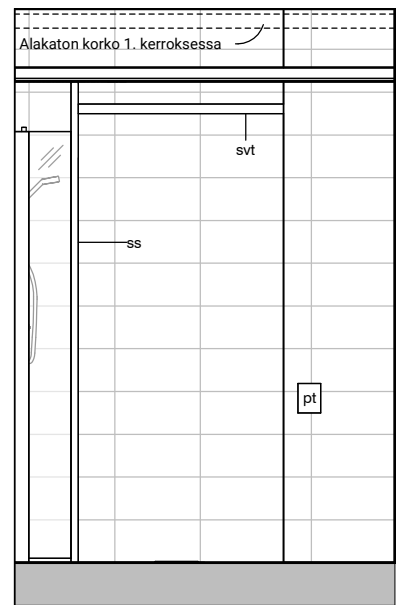

08b

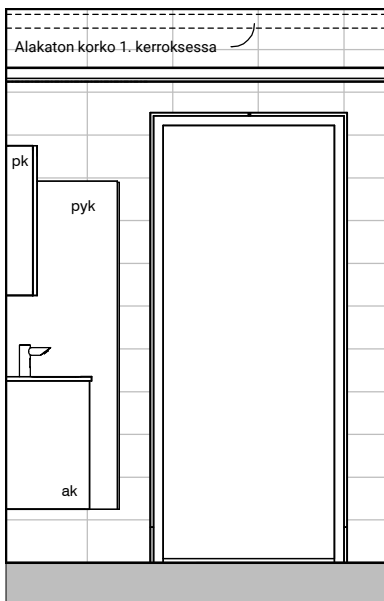

08c

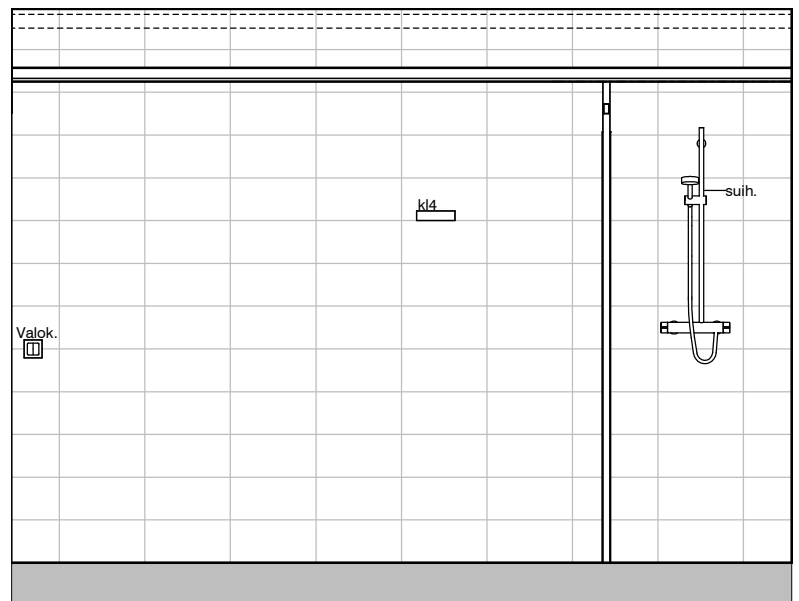

08d



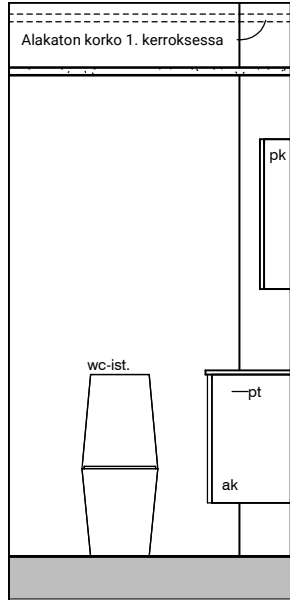
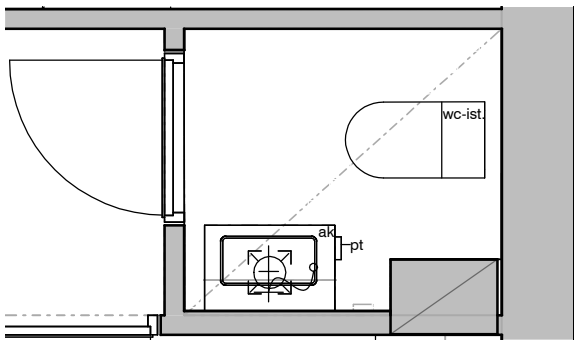

09f

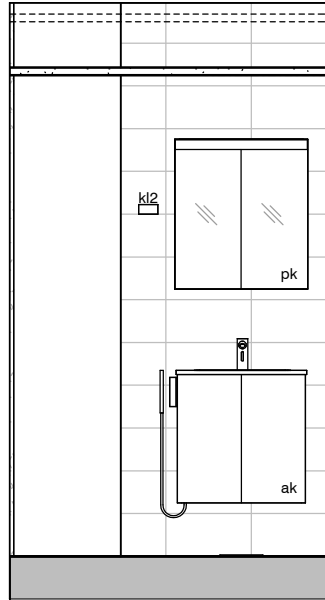

09g

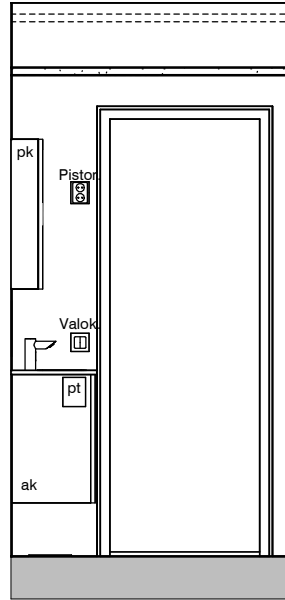

09h

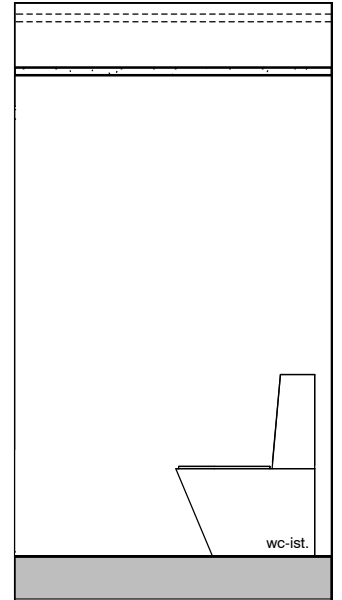

09i